

INSTALLATION INSTRUCTIONS **3300** LASER/RADAR DETECTOR

THE WHISTLER GROUP
CORPORATE HEADQUARTERS
13016 N. Walton Blvd.
Bentonville, AR 72712
TEL (501) 273-6012 FX (501) 273-2927
www.whistlergroup.com

PRODUCT DEVELOPMENT CENTER
25 Industrial Ave.
Chelmsford, MA 01824
TEL (978) 244-1400 FX (978) 244-1492

CUSTOMER RETURN CENTER
1201 N. Dixieland Rd.
Rogers, AR 72756
Consumer Relations Tel (800) 531-0004
Email: info@whistlergroup.com

P/N 3300INSTALL, © WHISTLER 2000



TABLE OF CONTENTS

Tools Required for Installation

- Phillips or Blade Screw Driver
- 3/8" Open End Wrench
- Electric Drill
- Drill Bits: 3/16", 5/64", 7/64", 9/64", and 13/64"
- Other Tools May Be Required Based On Your Vehicle Type Or Requirements For Customized Installation

Dimensions:

- Control Panel: .8" H x 2.8" W x 2.4" L
- Radar Antenna: 1.4" H x 4.0" W x 3.6" L
- Laser Antenna (LRM-5): 1.9" H x .9" W x .6" L

Cable Lengths:

- Radar Antenna Cable: 25'
- Laser Antenna (LRM-5): Cable: 9'
- Power Cable: 4'

Specifications are subject to change without notice.

Topic	Page
Whistler 3300 Components	2
Mounting Brackets	3
Mounting Fasteners	4-5
Installation Of Radar Antenna	6-10
Installation Of Temperature Probe	10
Installation Of LRM-5	11-12
Installation Of Control Panel	13-15
Optional Accessories	16
Troubleshooting Guide	17-18

WHISTLER 3300 COMPONENTS

Radar Antenna

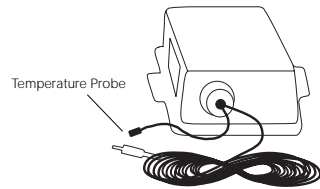

The waterproof radar antenna with Temperature Probe is mounted at the front of your vehicle, usually behind the grill.

Control Panel And Power Cable

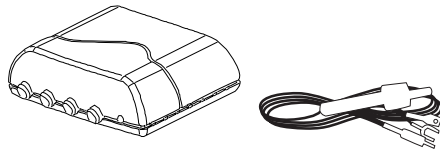

The compact control panel is mounted on the dash in a location convenient for viewing. The power cable plugs into the control panel.

Whistler LRM-5

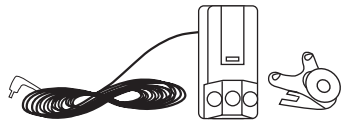

The LRM-5 (Laser Receive Module) is mounted inside your vehicle using the windshield bracket or Hook and Loop Fastener.

2

MOUNTING BRACKETS

Antenna Mounting Brackets And 45° Reflector

Small L
Brackets (2)



Large L
Bracket (1)

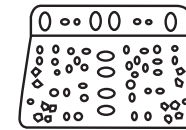

45° Reflector
(For use when
mounting antenna
in vertical position.)

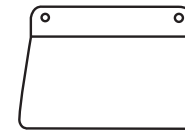

Control Panel Mount Brackets

Hanging
Bracket

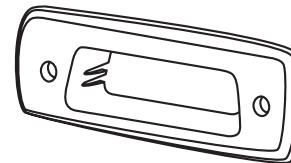
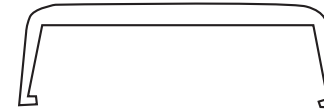

Thru Dash
Bracket

3

MOUNTING FASTENERS

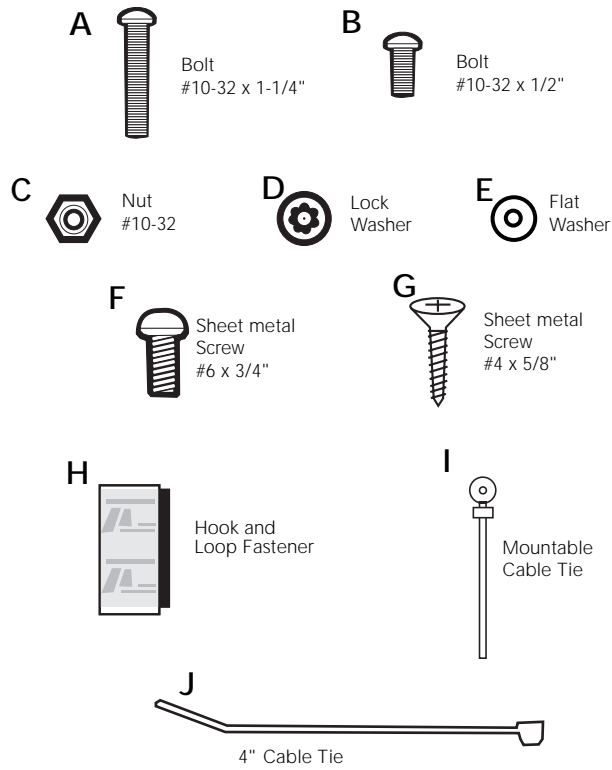

4

MOUNTING FASTENERS

Reference	Description/Use	Qty.
A	Bolt #10-32 x 1-1/4" • Fastens Large L or Small L Bracket to vehicle support.	2
B	Bolt #10-32 x 1/2" • Fastens Small L to Large L Bracket (optional approach).	2
C	Nut #10-32 • Use with #10-32 bolts.	4
D	Lock Washer • Use with #10-32 bolts.	4
E	Flat Washer • Use with #10-32 bolts.	2
F	Sheet metal Screw #6 x 3/4" • Fastens Large L/Small L Bracket or 45° Reflector to radar antenna. Mounts Temp. Probe.	7
G	Sheet metal Screw #4 x 5/8" • Fastens Hanging Bracket to interior vehicle surface.	2
H	Hook & Loop 1/2" x 1" • Fastens LRM-5 to back of rearview mirror when windshield bracket is not used.	1
I	Mounting Cable Tie • Secures Temperature Probe to vehicle.	1
J	4" Cable Tie • Secures cable from radar antenna at various locations in engine compartment.	5

Note: If mounting fasteners are missing from your package, call 1-800-531-0004 for replacements.

5

INSTALLATION OF RADAR ANTENNA

General Information

The radar antenna is waterproof and designed to be mounted at the front of your vehicle. In most vehicles the best mounting location is directly behind the grille; however, other locations which provide concealment and/or protection of the antenna may be acceptable. Radar signals will pass through non-metallic materials such as fiberglass and plastic, however, be sure to mount the receiver away from any metal, as it will block the receiver's antenna. Because the optimal location for mounting the antenna varies by vehicle type, the hardware supplied is designed to offer a wide variety of mounting options. We suggest choosing the option that enables the antenna to be securely fastened and provides the ANTENNA window adequate forward visibility.

NOTE: Use of hardware that is not supplied or DRILLING into the case will cause damage to the receiver and void the warranty.

Antenna Mounting Brackets

There are two types of mounting brackets for the antenna: Large L (1) and Small L (2). The Large L bracket fastens to the antenna using two or more screws (#6 x 3/4"). Slide the screw through the hole on the flange of the antenna and then tighten into the metal bracket (do not over tighten). The Large L Bracket may be fastened to the antenna in a variety of positions as shown on page 7.

6

INSTALLATION OF RADAR ANTENNA

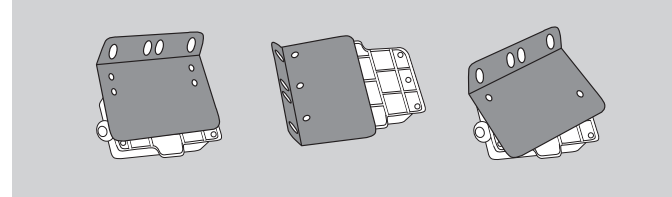

The layout of holes on the large L Bracket accommodates multiple antenna mounting positions.

This arrangement provides flexibility for fastening the antenna /bracket assembly to your vehicle in a manner that allows the antenna window (ANTENNA) to have a forward looking view of the road ahead.

The Small L Brackets (2) may also be fastened to the antenna in different positions as shown below:

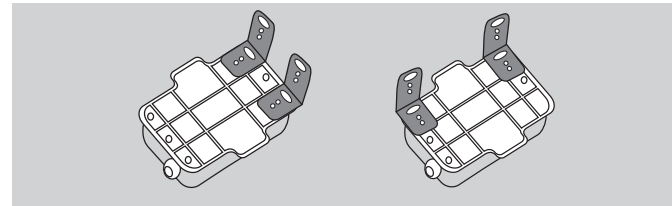

The Small L Brackets may be fastened to any of the six holes on the antenna.

Use one #6 x 3/4" screw to fasten each Small L Bracket to the antenna. Again, do not over tighten the screws.

In some situations it may be advantageous to use both the Large L and Small L Brackets to install the antenna in a vehicle.

7

INSTALLATION OF RADAR ANTENNA

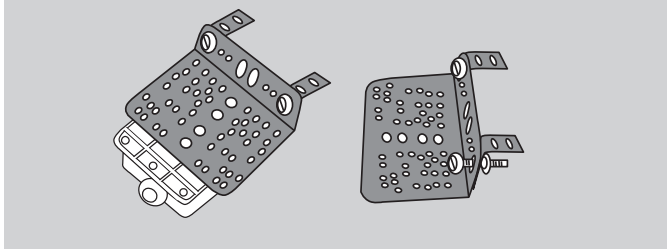

Large L and Small L Brackets may be used in combination.

The Small L Brackets are fastened to the Large L Bracket using the #10-32 x 1/2" bolts, #10-32 nuts and lock washers.

To fasten the Large L or Small L Brackets to your vehicle, mark the supporting structure through the appropriate holes in the brackets, then drill the holes in the supporting structure with a 13/64" drill bit. Attach the bracket(s) to the supporting structure using two bolts (#10-32 x 1-1/4") and corresponding nuts, flat washers, and lock washers. You may also use 2 #6 sheet metal screws. Because rough road surfaces can cause excessive vibration or bouncing, be certain to fasten the bracket(s) securely to your vehicle.

Horizontal Or Vertical Mounting Of Antenna

The antenna can be attached to the vehicle in a horizontal or vertical position, or at any angle between these two points. Select the position that allows you to fasten the antenna to your vehicle in the most secure manner.

8

INSTALLATION OF RADAR ANTENNA

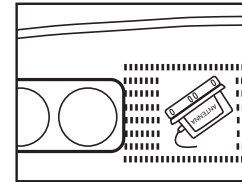

Best mounting angle for optimum detection of all types of radar guns.

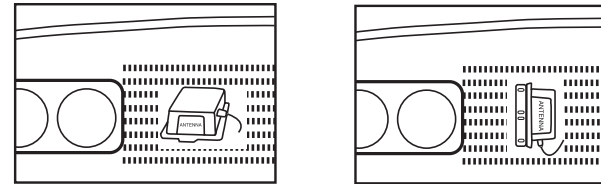

Radar antenna mounted in horizontal position.

Horizontal Mounting

When mounting the antenna in a horizontal position (or on an angle between), remember to keep the ANTENNA window as close to perpendicular as possible to the road surface (ANTENNA window should not be angled up toward the sky or down toward the road surface).

Mounting Vertical (with 45° Reflector)

For vehicles that do not have sufficient clearance behind the grille (about 5") to mount the antenna in a horizontal position, the 45° Reflector should be used.

The 45° Reflector is attached to the antenna with two screws (#6 x 3/4") on the side of the antenna housing marked ANTENNA. Slide the screws through the corner holes on the flange of the antenna housing and then tighten into the metal reflector (do not over tighten).

9

INSTALLATION OF RADAR ANTENNA

Mount the antenna to the vehicle such that the ANTENNA window is facing the road surface, sky, right or left of the vehicle, and the reflector has an unobstructed view of the road ahead.

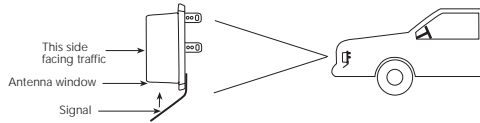

Radar antenna mounted(vertical) with 45° Reflector.

Mounted in this position, radar signals are reflected into the ANTENNA window.

Mounting the Temperature Probe

Find a location that is far enough away from engine and radiator heat but still in the airflow for the vehicle. Mounting the Probe too close to these heat areas will give a false high temperature.

- Attach the mountable tie wrap (supplied) to the Temperature Probe as shown.
- Mark location for Probe, then drill a hole using a 7/64" drill bit. Attach Probe with tie wrap in the correct orientation using the #6 x 3/4 screws.

NOTE: Mount the Probe so that there is space between the Probe and the mounting area.

Do not mount Probe directly to metal area.

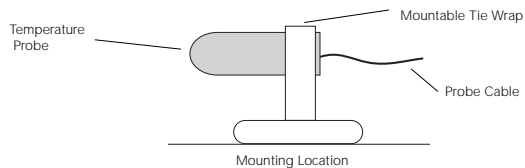

10

INSTALLATION OF LRM-5

Antenna Cable To Control Panel

Once the antenna is installed, run the cable along the edge of the engine compartment to the firewall. Find a location in the firewall where other wires (or the speedometer cable) enter the passenger compartment and feed the stereo jack connection through. Be careful not to interfere with or disconnect other wires, cables, or mechanical systems of your vehicle while routing the antenna cable. Also, keep the antenna cable away from any areas in the engine compartment that may become hot. Cable ties are provided to secure the antenna and Temperature Probe cables at various points in the engine compartment.

General Information

The LRM-5 (Laser Receive Module) provides both front and rear laser reception. Mount the LRM-5 with the 3-lens array facing forward (down the road) and the single lens facing behind. This approach offers the greatest protection, since you will most often be traveling into a laser signal, rather than away from it when laser speed enforcement is encountered. For effective protection, make sure the LRM-5 has an unobstructed view forward and behind, and that it is not placed behind metallic sun screens.

Mounting The LRM-5

The LRM-5 can be mounted to the front windshield using the windshield bracket supplied.

11

INSTALLATION OF LRM-5

Before using, attach the suction cup and rubber bumpers (2) to the metal bracket. If necessary, you may bend the metal bracket in order to position the LRM-5 correctly (3-lens array facing forward, single lens facing behind.)

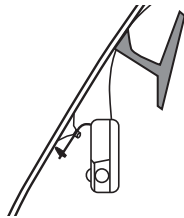

LRM-5 mounted with windshield bracket.

Using Hook & Loop Fasteners, the LRM-5 may also be mounted to the back side of your rearview mirror. Be careful not to block the rear facing lens when mounted in this manner. Also, clean the appropriate surfaces with isopropyl alcohol before adhering the adhesive side of the fastener to those surfaces.

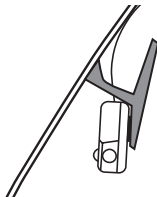

LRM-5 mounted to rearview mirror with Hook & Loop Fasteners.

12

INSTALLATION OF CONTROL PANEL

General Information

The control panel may be mounted using the Under Dash Bracket or Hook & Loop fastener supplied. As an alternative, you may also use a Through Dash Bracket. When choosing a mounting location, consider your needs for ease of viewing the display, accessibility of controls (remember Mute Mode may be used frequently), and concealment.

Control Panel Mounted With Under Dash Bracket

Fasten the Under Dash Bracket to your vehicle's dash with the two #4 x 5/8" sheet metal screws provided. A 5/64" drill bit should be used to drill pilot holes for the screws. Use the holes in the bracket to mark the location for pilot holes.

Once the bracket is fastened to your vehicle, the control panel can be attached to it. However, we suggest connecting all cables to the back of the control panel before snapping it into the bracket. See page 15 for proper placement of cables.

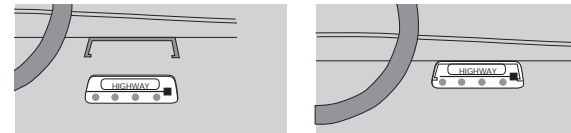

Control panel snaps into rather than slides onto the Under Dash Bracket.

13

INSTALLATION OF CONTROL PANEL

Control Panel Mounted With Hook & Loop Fasteners

Fasteners can be used to mount the top or bottom of the control panel to your vehicle. Before adhering the adhesive side of the fastener to a surface, clean that surface with isopropyl alcohol.

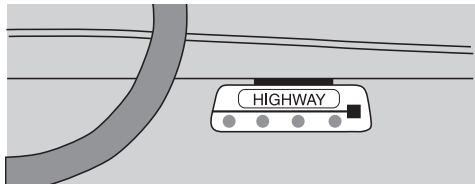

Use of Hook & Loop simplifies control panel installation.

Control Panel Mounted With Through Dash Bracket

Installation instructions are provided with the bracket. We recommend using a professional installer if you are not familiar with customized dashboard installations.

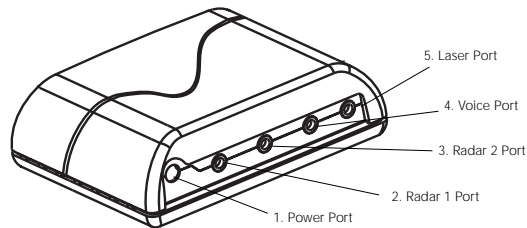

14

INSTALLATION OF CONTROL PANEL

Antenna Cable Connection

The stereo connector (straight end) on the end of the antenna cable plugs into **Radar 1** port (2) on the back of the control panel.

LRM-5 Cable Connection

After mounting the LRM-5, conceal the cable and plug the stereo jack connector (right angled end) into the port on the back of the control panel labeled **LASER** port (5).

Power Cable Connection

The power cable has a plug on one end which connects to the back of the control panel at the port labeled **PWR** port (1). At the other end of the power cable the power and ground wires are separated. The ground wire has a "U" type connector which should be fastened to a metal surface. Look for an existing screw or bolt under the dash to use as a grounding point. The power wire has a spade type connector which should be connected to a switched +12 volt DC circuit in your vehicle's fuse box. A switched circuit is one that has power when your vehicle is on, but has no power when your vehicle is off. Connect the "U" type connector to the ground point selected, attach the power cord plug to the control panel area marked "PWR" then touch the power wire to the +12 volt DC switched power source selected; if the control panel sounds the self test sequence, then all connections are correct.

15

OPTIONAL ACCESSORIES

Added Protection From Behind

For drivers interested in gaining increased detection range when radar is transmitted from behind, the Whistler 3300 can be upgraded with a second antenna. This antenna is mounted facing rearward and can be purchased from many Whistler retailers or directly from Whistler; ask for the SWRA-3300 (Superwideband Remote Antenna), Part Number 202964.

The Whistler 3300's control panel is designed to operate with the SWRA-3300; the **RADAR 2** port (3) is the input for the SWRA-3300 cable. On model 3300 an asterisk is displayed next to the Band ID (K * ||| |||) when radar signals are detected. The SWRA-3300 detects all radar guns operating on X, K, and superwideband Ka frequencies.

Instructions and mounting hardware for installing the SWRA-3300 are included with the unit.

More Volume

Real Voice Module (P/N 202971) can be used to articulate Band ID, Safety Warning and Feature Selection. Plugs into **VOICE** port (4).

NOTE: This is the only audio option that can be plugged into the Whistler 3300. Any other device may damage the unit and void the warranty.

TROUBLESHOOTING GUIDE

The Whistler 3300 is expertly engineered and designed to exacting quality standards to provide you with reliable, trouble-free operation. If your unit has been correctly installed following the guidelines in this manual, but is not operating optimally, please refer to the troubleshooting guide below.

PROBLEM: No display or audio
<ul style="list-style-type: none"> •Check fuse in power cable, replace if necessary. •Check fuse in fuse box, replace if necessary. •Make sure power cable is properly grounded.
PROBLEM: Unit alarms when using vehicle equipment or electrical accessories (brakes, power mirrors/windows, directionals, horn, etc.)
<ul style="list-style-type: none"> •Check condition of vehicle's electrical system, including battery and alternator. •Install a filter capacitor (470mfd. 25 volt or larger capacitor value) where power connection is made.
PROBLEM: Audio alerts are not loud enough.
<ul style="list-style-type: none"> •Cancel Auto Quiet Mode or City Mode. •Check audio level setting.
PROBLEM: Display shows R1 error. Also see Pg. 18-19 of Owner's Manual.
<ul style="list-style-type: none"> •Warning communicates "loss of link" between control panel and front antenna (RADAR 1). •Check antenna connection at back of control panel. •Contact factory, if you suspect antenna is defective.

TROUBLESHOOTING GUIDE

NOTES

PROBLEM: Display shows R2. Also see Pg. 18-19 of Owner's Manual.

- Warning communicates "loss of link" between control panel and rear antenna (RADAR 2); occurs only if rear antenna has been installed.
- Check antenna connection at back of control panel.
- If no rear antenna is installed, perform the factory reset procedure outlined in the owner's manual.
- Contact factory if you suspect rear antenna is defective.

PROBLEM: Display shows R2 ON?

- Rear antenna connected to RADAR 2 port. Press DARK for yes or CITY for no.
- R2 was shut off by a factory reset. See Reset Features section of owner's manual.

If difficulties occur which cannot be solved by information in this Troubleshooting Guide, please call Whistler Consumer Relations at 1-800-531-0004 before returning your unit for service, or contact us via email: info@whistlergroup.com.

NOTES

NOTES

