



LRD 937

REFERENCE GUIDE

The industry's most
advanced fully
integrated laser / radar
detectors

Uniden®

CONTENTS

OF YOUR REFERENCE GUIDE

Introduction.....	2
Feature Highlights.....	2
Included with Your Radar Detector.....	3
Speed Detection.....	4
Speed Detection Systems.....	4
Radar.....	4
Laser.....	5
Controls.....	6
Controls and Functions.....	6
Display Panel.....	7
Installation.....	8
Selecting a Location	8
Helpful Tips.....	9
Adjusting the Windshield Mounting Clip.....	10
Connecting the Power.....	11
Replacing the Fuse.....	12
Operation.....	13
Power On.....	13
Demonstration.....	13
Volume Control.....	13
Full Warning.....	14
Audio Alert Only Operation.....	14
Visual Alert Operation.....	15
Auto Mute Operation.....	15
City Operation.....	16
Safety Warning System Operation.....	17
Care and Maintenance.....	17
Troubleshooting.....	18
Specifications.....	19
Warranty.....	20
Warranty.....	21
Illustrations.....	inside back cover

Note : Foldout the back cover of this reference guide to refer to the "Illustrations" page.

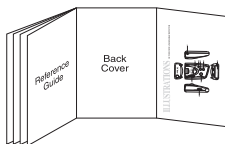

INTRODUCTION

TO YOUR NEW LASER/RADAR DETECTOR

Welcome to the world of sophisticated, early warning laser/radar detection. You have purchased one of the most advanced laser/radar detectors available. The LRD 937 is a completely integrated laser/radar detector. It responds to the X, K, and Ka-Super Wideband radar guns in use today and also provides 360° detection of the latest speed monitoring system — the laser gun. The built-in Safety Warning System (SWS™) is capable of detecting a hazardous warning signal.

The LRD 937 provides distinct visual and audio alerts to warn you of the presence of X, K, and Ka-Super Wideband radar signals as well as IR laser signals and Safety Warning System. You can drive with confidence when you bring along the LRD 937.

The LRD 937 employs a state-of-the-art electronic system designed to make this radar detector invisible to all current VG-2 radar detectors. The LRD 937 will also warn you of VG-2 use.

We are certain that you will enjoy the LRD 937, and to ensure that you get the most from its features, please read this Reference Guide carefully before installing and operating the unit.

FEATURE HIGHLIGHTS

- 360° Laser Detection
- Safety Warning System™
- All Band Coverage
- 8 Alarm Tones
- Super Wideband
- VG-2 Undetectable
- SWS, Laser priority
- Pulse Detection
- Warning Lights
- Visual Only Mode
- Auto Mute Mode
- Audio Only Mode
- Self Test
- City and Highway Modes

INCLUDED WITH YOUR RADAR DETECTOR

TIP

To get the most from your laser/radar detector, please read this Reference Guide thoroughly.

NOTE

Be sure to complete and mail the product registration card included with your radar detector.

WARNING

If any of these items are missing or damaged, immediately contact your dealer or the Uniden Parts Department at (800)554-3988. Hours are from 7:00 a.m. to 5:00 p.m. Central time Monday through Friday. We can also be reached on the Web at www.uniden.com



Reference Guide

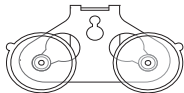

Windshield Clip



Printed Material



Fuse
(3AG / 2 Amp / 250V)

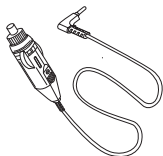

Cigarette Lighter Adapter

SPEED DETECTION SYSTEMS

IMPORTANT INFORMATION ABOUT
YOUR NEW LASER/RADAR DETECTOR

A speed detection device (often called a radar gun) sends out either a microwave signal or a beam of light. When this signal reaches its target, part of the signal is reflected or bounced back toward the emitting gun. The time required for the signal to leave the gun, bounce off an object, and return is used to determine a vehicle's distance and speed.

▼ RADAR

Radar (Radio Detection and Banging) is a microwave system for detecting the speed of moving objects by reflected pulses of high frequency radio waves. There are three radar bands (microwave frequencies):

X band (10.49 to 10.56GHz),

K band(24.04 to 24.26GHz), and the "superwide"

Ka ban (33.4 to 36GHz).

The X band was the first used for traffic, followed by the K band which is harder to detect (most instant-on radar is K band). The Ka band was introduced in 1987, and widened to Ka Super Wideband in 1990 by the FCC. The LRD 937 monitors all current radar bands including the entire Ka Super Wideband.

The radar beam is cone shaped — the narrower the beam, the greater the resolution. A moving vehicle reflects radar signals back towards the radar gun. The LRD 937 can detect the signals emitted by radar guns. It will sound an audio alarm and flash a warning indicator. For continuously transmitting radar, use the LRD 937 to get accurate detection from a safe distance. Weak signals cause the audio and visual alarms to activate intermittently, but as the signal gets stronger (the closer you get to the radar gun), both alarms increase in intensity.

Instant-on transmitters fire a short radar pulse beam at a vehicle and instantly read its speed. When detected at a distance, you will hear a few beeps and see the corresponding LED blink at a rate relative to the signal strength. The stronger the signal, the faster the blink rate. Instant-on radar signals are the most difficult to detect at a safe distance because they are transmitted only when directed at you or at a vehicle directly ahead of you.

▼ LASER

The Laser Speed Detection System, also called LIDAR (for Light Detection and Ranging), uses a laser gun that emits infrared light pulses just outside the spectrum of visible light. Each reflected pulse measures the speed of the object coming toward or going away from the laser gun.

Unlike radar, the laser gun emits a very narrow beam of light, so it can pinpoint a speeding car within traffic. The infrared beam spreads out, but slowly and over a longer distance than a radar signal.

The laser gun can acquire a speed reading as quickly as 0.3 seconds, sometimes less. However, since it isn't easy to accurately aim at and hit a moving target, an operator often moves the laser gun in several directions to get a reading. So laser signals are emitted continuously for a few seconds for each speed measurement.

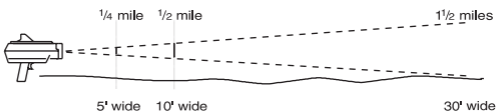



The LRD 937 can detect these light pulses from as far away as 1.5 miles, which is about four times the effective range of a laser gun (2,000 feet), and about ten times its average operating range (500-800 feet).



To be safe, do not ignore any warnings. Although there are other types of radar signals that may cause interference, when the LRD 937 detects a signal, be on the alert. It is important to exercise caution at all times.

CONTROL AND FUNCTIONS

AND FUNCTIONS OF YOUR LASER/RADAR DETECTION

1. Clip Release — Press the clip release button to remove the LRD 937 from the windshield mounting clip.
2. Rear and Side Laser Detector Lense — For rear and side detection of laser signals.
3. **CITY**  Press the **CITY** button to help reduce X band false alarms while driving in the city. When you turn on the City Mode, the City indicator turns on. While driving on highways, turn off the City Mode for long-range detection.
4. **AUDIO**  Press the **AUDIO** button to activate the Audio Alert Only operation. All the LEDs intensity change from bright to dim.
5. **MUTE**  Press the **MUTE** button to activate the Auto Mute feature, which produces a full alert level when a signal is first received, then automatically reduces to chirps for the rest of the warning.
6. Speaker — Sounds audio alert. There are eight different audio alert tones to distinguish each type of signal received. When you become familiar with all the distinct alert tones, you can operate the LRD 937 just by listening, devoting your full attention to the traffic in front of you.
7. DC 12V Power Input — Connect the DC power cord here.
8. On-Off/Volume Control — Turns the power on and adjusts the Audio Alert volume.
9. Display Panel — LEDs display laser/radar alerts, operation mode, Safety Warning System (SWS) Alert.

NOTE: Foldout the back cover of this reference guide to refer to the “Illustration” page.

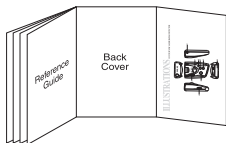

DISPLAY PANEL

The LED display panel indicates each mode of operation, when a signal is not received.

At **City** mode : "C" LED light turns on.

At **Highway** mode : "C" LED light turns off.

At **Audio** mode (dim) : The intensity of all LEDs are reduced to dim.

At **Audio-only** mode (dark) : All LEDs except "P" turn off.

At **Mute-on** mode : "P/M" LED blinks.

At **Mute-off** mode : "P/M" LED turns on.



Every time you turn on the LRD 937, a self test is performed for all visual and audio alerts. You will hear, in-order, eight distinct tones for the X, K, and Ka-Super Wideband radar bands, as well as Laser, SWS and VG2.

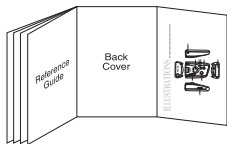
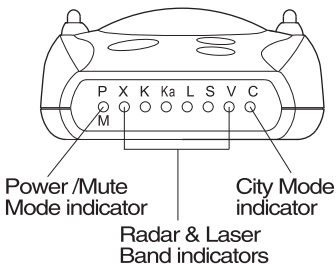

NOTE: Foldout the back cover of this Reference Guide to refer to the "Illustrations" page.

SELECTING A LOCATION

The LRD 937 uses a highly sensitive horn-type antenna and IR laser sensor to receive laser/radar signals. Its sensitivity and range depend on the method of installation and the direction of the antenna/sensor in relation to the signal source.

The inherent nature of radar waves makes them reflect off metallic surfaces. This is why these waves are so useful for measuring the speed of a vehicle. The IR laser light may reflect only from shiny surfaces. Both radar waves and IR laser light will, however, pass through plastic or glass.

Before you decide where to put your radar detector, please keep in mind these two important factors:

- For safety, do not mount the LRD 937 in a location where it will obstruct your driving vision.
- Most vehicles have the top part of the windshield tinted. Mounting the LRD 937 behind tinted or mirrored glass may reduce the effectiveness of laser detection by reducing the amount of laser light received by the detector.

HELPFUL TIPS

The antenna and the forward looking sensor are located behind the rear panel of the unit, (and the rear- and side-looking sensors are located on top of the unit), directly behind the mode selection keys. The antenna and sensors should not be obstructed by metal or metallic surfaces and should be pointed at the horizon for accurate long-range detection.

- Do not mount the unit behind the windshield wiper blades, radio antenna, tinted glass area, or mirrored glass. Be sure the unit is free from obstruction by seat backs, rear view mirror, sun visors, or the ceiling of the automobile.
- Do not mount the unit in front of the heater or defroster vents.
- Do not leave the unit in direct sunlight or in the glove compartment of a closed car for long periods of time, as extreme changes in temperature may cause internal damage. Also, removing the unit from the windshield makes you less susceptible to break-in and theft.

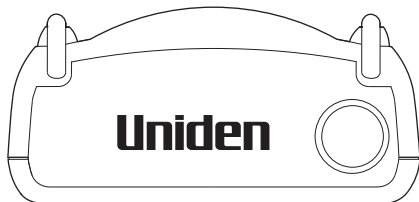

ADJUSTING THE WINDSHIELD MOUNTING CLIP

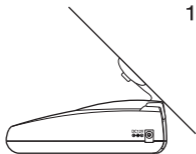

1. The metal portion of the bracket locks into the unit at two different positions. These positions can be used for vehicles with two different vertical angles of their windshields. The back position can be used for vehicles with windshields that are slanted back.

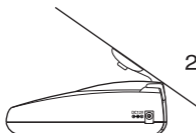

2. For optimum laser detection, gently bend the angled portion of the windshield mounting bracket so that the LRD 937 is parallel to the road surface. Be sure the LRD 937 is mounted so it is free of obstructions from seat backs, rear view mirror, sun visors, or the ceiling of the automobile. There must be a clear 360° line of sight to the outside of the vehicle.

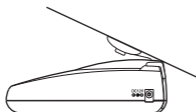

To mount the LRD 937:

1. Press the button on top of the radar and insert the windshield clip into the LRD 937. The metal portion of the bracket locks into the unit.
2. Place the bracket and the LRD 937 in the proper location on the windshield of your vehicle, and press the suction cups firmly against the windshield.

CONNECTING THE POWER

The LRD 937 is designed to operate on most 12 VDC negative ground vehicle electrical systems. The power cord provided with the unit has a cigarette lighter socket plug at one end and a small connector at the other.

1. Insert the small connector into the jack on the side of the unit.

TIP

Use only a Uniden supplied power cord or its replacement. Replacement power cord is available through the Uniden Parts Department. (800)554-3988 Refer to page 3 for hours of operation.

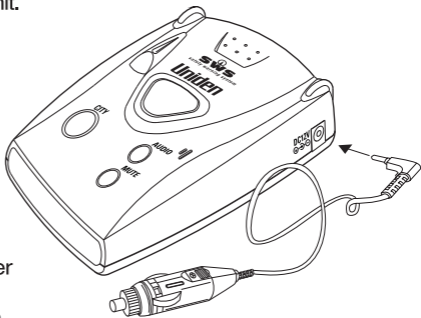

2. Insert the other end into the cigarette lighter socket of your vehicle.

When installing the power cord, make sure that:

- The socket is clean to allow proper contact.
- The power cord does not block the antenna area on the back of the unit.

REPLACING THE FUSE

The cigarette lighter plug contains a 2-ampere fuse to protect it from power surges.

1. To replace the fuse, unscrew the top of the plug.



2. Remove the fuse and replace it with the same type.

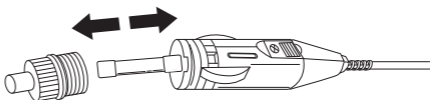

3. To replace the top, push in the two metal contacts and twist into place.

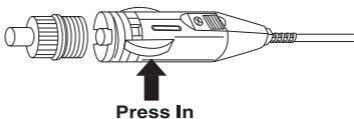

You are now ready to enjoy the convenience and security of your LRD 937. Please read this section of the Reference Guide carefully to familiarize yourself with the basic operation of this unit.

POWER ON

Turn the volume control to switch on the power. When you power up the LRD 937, it performs a self-test of all its circuits as it automatically demonstrates the process in the following order : X → K → Ka → Laser → SWS → VG2. You will hear all the different alert tones and see the corresponding LEDs light. After the LRD 937 confirms proper operation, the alert tones turn off and the LED under P/M on the display panel remains lit and represents the operational mode.

DEMONSTRATION

To demonstrate the audio and visual alerts, press and hold the **CITY** button while turning on the LRD 937. Next, press the **CITY** button. It gives you the audio and visual alerts for X-band. You can demonstrate all the audio and visual alerts for each band by pressing the **CITY** button repeatedly. It is programmed to demonstrate its operations in the following band order: X → K → Ka → PROLaser → Ultralyte → LTI2020 → SWS → VG2. When you finish, press **AUDIO** button to cancel the demonstration mode.

VOLUME CONTROL

Adjust the VOLUME control to a comfortable alarm tone level for your vehicle. The volume level does not have any effect on the unit's sensitivity. It is best to adjust the audio alarm during the self-test.

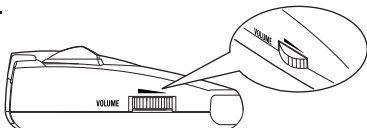

FULL WARNING

When the LRD 937 detects a radar, laser, or Safety Warning Signal, it emits a distinct warning tone and the corresponding visual LEDs will light. The blink rate of the LEDs and the audio of the Alert level increases successively as the signal source comes closer.

AUDIO ALERT ONLY OPERATION

Press the **AUDIO** button for Audio Alert only operation.

NOTE

Make sure the **VOLUME** control is not set to minimum during Audio Alert only operation.

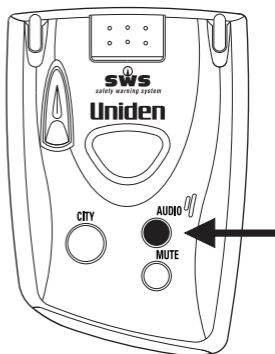

Audio Alert only operation is useful for reducing visual distractions. The intensity of all LEDs are reduced to dim after the first press of the **AUDIO** button. When the **AUDIO** button is pressed again, the Radar and Laser Band LEDs (X, K, Ka, L, S, and V) are turned off. If the **AUDIO** button is pressed again, the unit returns to full Alert operation (Audio and Visual Alert).

VISUAL ALERT ONLY OPERATION

You can operate the LRD 937 in Visual Alert only by setting the **VOLUME** control at the minimum position in Full Alert Mode. At this setting you can barely hear the audio alert in a quiet environment.

AUTO MUTE OPERATION

Press the **MUTE** button to activate the Auto Mute feature. The P/M LED blinks to confirm this mode is selected.



If the volume control is turned down and Audio Only operation is selected, the alarm features are completely disabled.

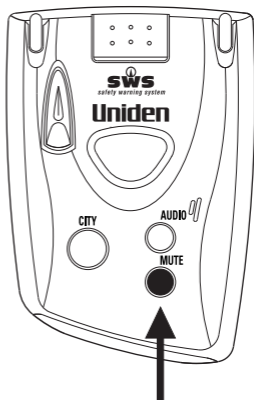

When the Mute is selected, the unit is in Auto Mute Mode. In this mode you hear the full audio alert when a signal is first received. The audio alert automatically reduces to a chirp for the duration of the warning.

CITY OPERATION

In highly populated areas, you may encounter many devices that use the same frequencies as radar signals, such as motion detectors, automatic doors, and intrusion alarms. These devices may trigger an alert called “falsing.”

To filter most of the weaker signals and get the most accurate radar signal recognition, press **CITY** to turn on the City mode. The “C” LED lights when City mode is selected.

TIP

If you use both the Audio Only Alert and City modes, you will not receive an audio alert until you are very close to the radar source.

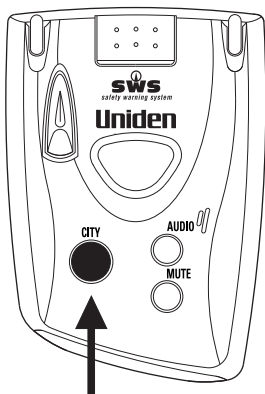

SAFETY WARNING SYSTEM OPERATION

The Safety Warning System (SWS) is a new communication system that will provide an early warning when a road hazard exists. The LRD 937 is capable of detecting the SWS signal broadcast on the K band by either law enforcement, emergency services or local departments of transportation. When the alert sounds and the LED under "S" on the display panel begins to flash, you should turn to local radio traffic reports, prepare to slow down or stop your vehicle. You could be approaching an accident, or bad road conditions caused by weather, road crews, or construction.

CARE AND MAINTENANCE

The LRD 937 is designed to give you years of trouble-free service. There are no user-serviceable parts inside, except for the fuse. No maintenance is required. To keep your detector in like new condition, follow these important suggestions:

- Never leave the LRD 937 on the windshield when you park your vehicle. The temperature in the vehicle in the summer can reach levels above what is considered to be safe for this unit.
- To make you less susceptible to break-in and theft, remove the unit from your windshield when you leave your vehicle.
- Do not expose the unit to moisture. Rain, dew, road splash, or other liquids can damage the internal components and reduce sensitivity of the LRD 937.

TROUBLESHOOTING

If your LRD 937 does not perform to expectations, try the suggestions listed below. If you cannot get satisfactory results, call the Uniden Customer Service Center at (800) 297-1023, 7:00 a.m. to 7:00 p.m. Central Time, Monday through Friday.

YOUR NEW LASER/RADAR DETECTOR

PROBLEM	SUGGESTION
Unit does not operate. (No indications on the display panel)	<ul style="list-style-type: none"> • Check the power cord. Be sure the connectors are properly installed. • Be sure ignition key is ON or in the accessory position. • Fuse out. Check and replace. • Check power to lighter socket. • Vehicle electrical problem exists. • Make sure that the volume control is in the ON position. • Clean cigarette lighter socket.
Unit fails the self test.	<ul style="list-style-type: none"> • Call Uniden Customer Service Center, (800) 297-1023.
Weak detection.	<ul style="list-style-type: none"> • Check angle of unit. Point to the horizon. • Antenna/Sensor is obstructed. Move the unit clear of any obstruction outside the windshield, such as a wiper blade. • Move the unit clear of the window tint.
Inaccurate or erratic detection.	<ul style="list-style-type: none"> • Loose power cord. Check both connectors. • Power cord is broken. Check and replace.
Beeps over bumps or rough road.	<ul style="list-style-type: none"> • Check that the power cord is connected at both ends. • Clean cigarette lighter socket.
Beeps at same location.	<ul style="list-style-type: none"> • Falsing because you have passed a motion sensor or alarm.
LEDs are blinking , but no audio.	<ul style="list-style-type: none"> • For highway use, make sure the City Mode is OFF. • Increase the volume.
The unit bounces against the windshield.	<ul style="list-style-type: none"> • Reposition the unit so that the bumpers are firmly against the windshield.

GENERAL

Dimensions:	3.8in(L) x 2.6in(W) x 1.3in(H)
Weight:	4.0oz
Power Requirements:	12 ~ 16VDC, 310mA
Temperature Range:	Operating: -5°F to 160°F (-20°C to 70°C) Storage: -40°F to 185°F (-40°C to 85°C)

360° LASER DETECTOR

Receiver Type:	Pulse Laser Signal Receiver
Sensor Front End:	Convex Condenser Lens
Detector Type:	Pulse Width Discriminator
Receiver Bandwidth:	30 MHz
Spectral Response:	800-1100 nm
Alert Hold Time:	3 seconds

RADAR DETECTOR

Receiver Type:	Dual Conversion Superheterodyne
Detector Type:	Scanning Frequency Discriminator
Antenna Type:	Linear Polarized, Self-Contained Antenna
Sensitivity:	X band = -110 dBm/cm ² K band = -110 dBm/cm ² Ka Super Wideband = -100 dBm/cm ²
Frequency of Operation:	10.490 - 10.560 GHz (X band) 24.040 - 24.260 GHz (K band) 33.40 - 36.00 GHz (Ka Super Wideband)

Specifications subject to change without notice.

ONE YEAR WARRANTY

Important: Evidence of original purchase is required for warranty service.

WARRANTOR: UNIDEN AMERICA CORPORATION (“Uniden”)
ELEMENTS OF WARRANTY: Uniden warrants, for one year, to the original retail owner, this Uniden product to be free from defects in materials and craftsmanship with only the limitations or exclusions set out below.

WARRANTY DURATION: This warranty to the original user shall terminate and be of no further effect 12 months after the date of original retail sale. The warranty is invalid if the product is (A) damaged or not maintained as reasonable or necessary, (B) modified, altered, or used as part of any conversion kits, subassemblies, or any configurations not sold by Uniden, (C) improperly installed, (D) serviced or repaired by someone other than an authorized Uniden service center for a defect or malfunction covered by this warranty, (E) used in any conjunction with equipment or parts or as part of any system not manufactured by Uniden, or (F) installed or programmed by anyone other than as detailed by the owner’s manual for this product.

STATEMENT OF REMEDY: In the event that the product does not conform to this warranty at any time while this warranty is in effect, warrantor will either, at its option, repair or replace the defective unit and return it to you without charge for parts, service, or any other cost (except shipping and handling) incurred by warrantor or its representatives in connection with the performance of this warranty. Warrantor, at its option, may replace the unit with a new or refurbished unit.

THE LIMITED WARRANTY SET FORTH ABOVE IS THE SOLE AND ENTIRE WARRANTY PERTAINING TO THE PRODUCT AND IS IN LIEU OF AND EXCLUDES ALL OTHER WARRANTIES OF ANY NATURE WHATSOEVER, WHETHER EXPRESS, IMPLIED OR ARISING BY OPERATION OF LAW, INCLUDING, BUT NOT LIMITED TO ANY IMPLIED WARRANTIES OF MERCHANTABILITY OR FITNESS FOR A

WARRANTY

PARTICULAR PURPOSE. THIS WARRANTY DOES NOT COVER OR PROVIDE FOR THE REIMBURSEMENT OR PAYMENT OF INCIDENTAL OR CONSEQUENTIAL DAMAGES. Some states do not allow this exclusion or limitation of incidental or consequential damages so the above limitation or exclusion may not apply to you.

LEGAL REMEDIES: This warranty gives you specific legal rights, and you may also have other rights which vary from state to state. This warranty is void outside the United States of America.

PROCEDURE FOR OBTAINING PERFORMANCE OF WARRANTY: If, after following the instructions in the owner's manual you are certain that the product is defective, pack the product carefully (preferably in its original packaging). The product should include all parts and accessories originally packaged with the product. Include evidence of original purchase and a note describing the defect that has caused you to return it. The product should be shipped freight prepaid, by traceable means, to warrantor at:

Uniden America Corporatio
4700 Amon Carter Blvd
Ft. Worth, TX 76155

1(800)297-1023
7:00a.m. to 7:00p.m. Central
Monday through Friday

©March 2001 Uniden America Corporation All rights reserved
Printed in Korea LRD 937

ILLUSTRATIONS

OF YOUR NEW LASER/RADAR DETECTOR

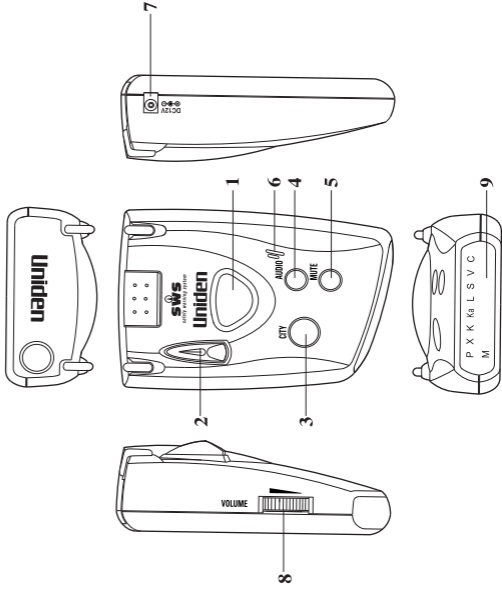

**At Uniden,
we'll take care of you!**

**If you need any assistance
with this product, please call our
Customer Hotline at:**

1-800-297-1023

**PLEASE DO NOT RETURN THIS PRODUCT
TO THE PLACE OF PURCHASE.**

**Our Uniden representatives will be
happy to help you with any matters
regarding the operation of this unit,
available accessories, or any other
related matters.**

**Hours: M-F 7:00 a.m. To 7:00 p.m.,
Central Standard Time**

**Thank you for purchasing
this Uniden product.**

THANK YOU

FOR PURCHASING A UNIDEN PRODUCT!

Uniden®

Covered under one or more of the following U.S. patents:
4,622,553 4,698,632 4,709,407 4,791,420 4,831,498
5,315,302 5,469,287 5,579,012 5,835,052

© 2001 Uniden America Corporation

All rights reserved