

Installation Instructions **Pro-3600** Laser/Radar Detector

THE WHISTLER GROUP, INC.
CORPORATE HEADQUARTERS
3604 NW Frontage Rd.
Bentonville, AR 72712
TEL 479.273.6012 FX 479.273.2927

P/N 202903 © The Whistler Group, Inc 2010

www.whistlergroup.com



WHISTLER

www.whistlergroup.com

TOOLS REQUIRED

Tools Required For Installation

- Phillips Screwdriver
- 3/8" Open End Wrench
- Electric Drill
- Drill Bit: 1/4", 13/64", 15/32" and #32 Bit
- Other Tools May Be Required Based On Your Vehicle Type Or Requirements For Customized Installation

Dimensions:

- Control Panel: .95" H x 3.22" W x .58" L
- Laser/Radar Antenna: 1.74" H x 3.54" W x .90" L
- Interface Box: 2.36" H x 4.40" W x .90" L
- Voice Module: 2.19" W x 1.21" L

Cable Lengths:

- Laser/Radar Antenna Cable: 3'
- Voice Module Cable: 6'
- Control Panel Cable: 6'
- Alert/Security LED Cable: 6'
- Power Cable: 6'
- Interconnecting Cable: 20'

Specifications are subject to change without notice.

TABLE OF CONTENTS

Topic	Page
Tools Required	1
Components	3 - 4
Mounting Brackets	5
Mounting Fasteners	6
Installation of Laser/Radar Antenna	7 - 11
Installation of Temperature Probe	11
Installation of Interface Box (iBox)	12 - 13
Installation of Alert LED	13
Installation of Optional Laser Antenna	14 - 15
Installation of Control Panel	16
Installation of Voice Module	17
Installation of Optional Rear Laser/Radar Antenna	17
Installation of Optional GPS Module	18
Power Connections	19
Error Codes	20
Troubleshooting Guide	21
Optional Accessories	22
Installation of Through Dash Bracket	23 - 24

Pro-3600 COMPONENTS

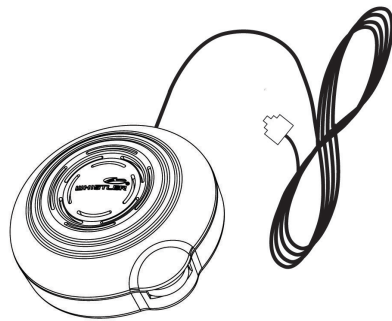
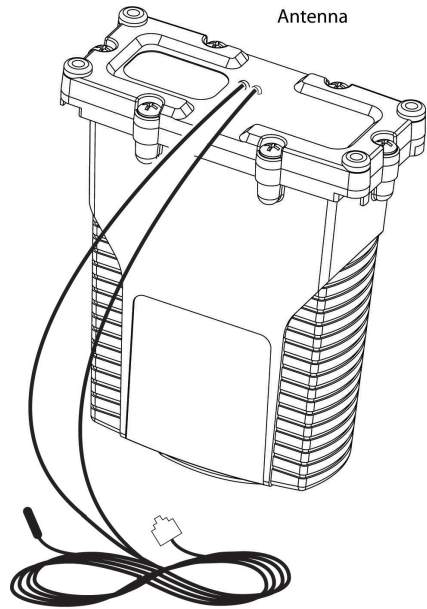

3

Pro-3600 COMPONENTS

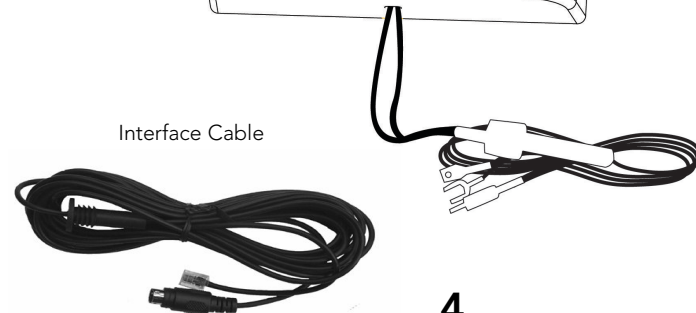
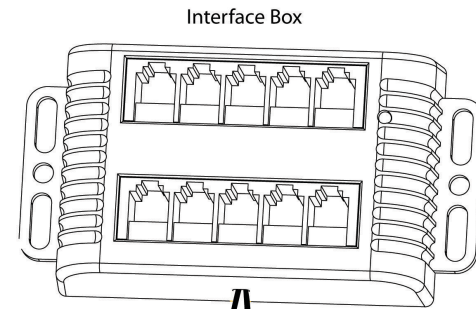
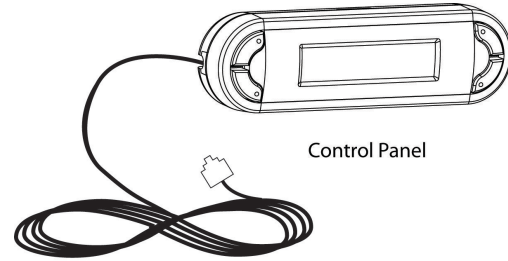

4

MOUNTING BRACKETS

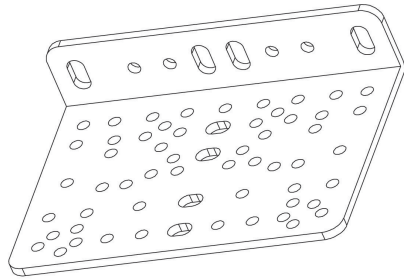

Large Bracket
Q'TY 1EA

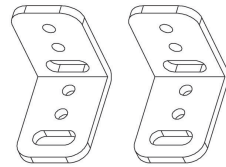

Small Bracket
Q'TY 2EA

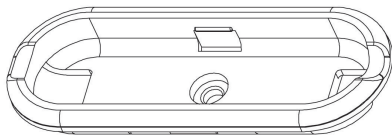

CONSOLE CRADLE
Q'TY 1EA

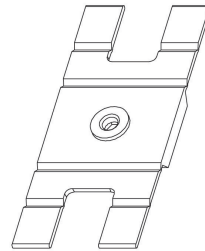

CRADLE BRACKET
Q'TY 1EA

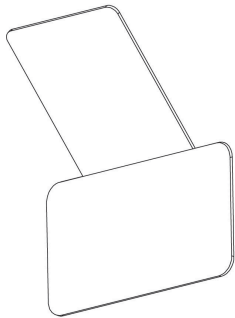

Reflector
Q'TY 1EA

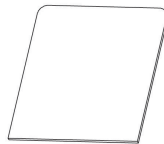

Tape Reflector (3M)
Q'TY 1EA



Tape Console (3M)
Q'TY 6EA

5

MOUNTING FASTENERS

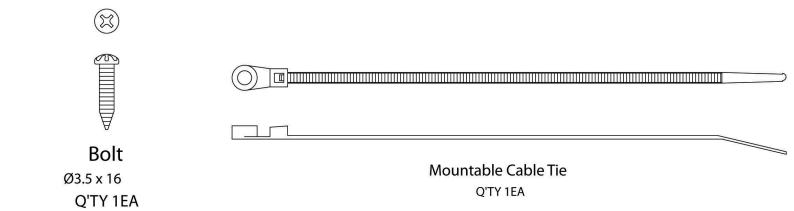
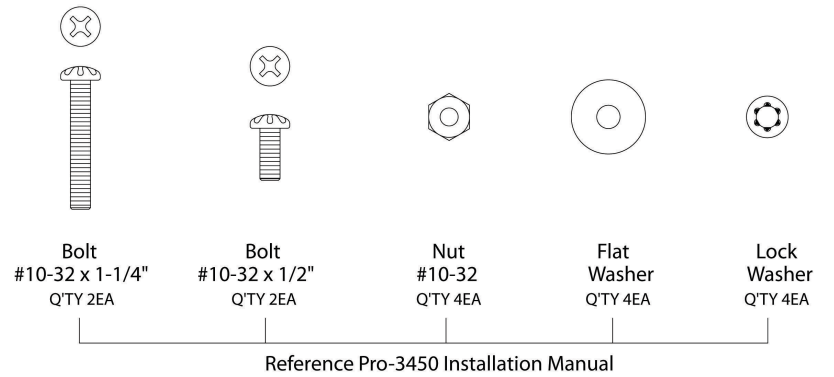
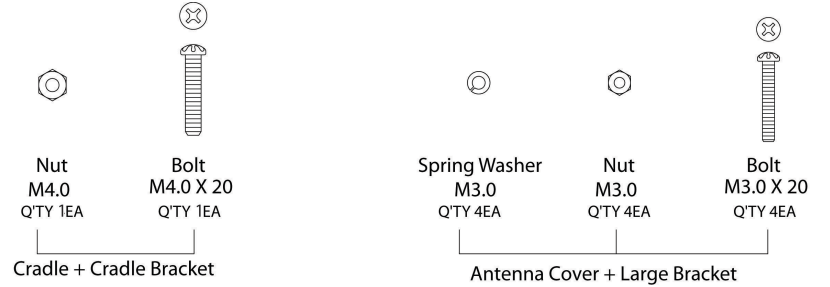

Mountable Cable Tie



Cable tie

6

INSTALLATION OF LASER/RADAR ANTENNA

General Information

The laser/radar antenna is waterproof and designed to be mounted at the front of your vehicle. Optimum mounting location is near the license plate area. Since this module also includes a Laser receiver, the front of this module needs to “look” down the road with no obstructions. Radar signals will pass through non-metallic materials such as fiberglass and plastic, however, because of the laser receiver, there can be no material blocking the receiver’s antenna window. If obstruction cannot be avoided, consider the vertical mounting option. Because the optimal location for mounting the antenna varies by vehicle type, the hardware supplied is designed to offer a wide variety of mounting options. We suggest choosing the option that enables the antenna to be securely fastened and provides the antenna window adequate forward visibility.

NOTE: The “antenna window” is the bubble area on the case. All references to antenna in this manual will be the bubble area.

NOTE: Use of hardware that is not supplied or DRILLING into the case will cause damage to the receiver and void the warranty.

TIP: Use removable thread lock on the hardware to prevent any bolts from backing out due to vibrations.

Antenna Mounting Brackets

There are two types of mounting brackets for the antenna: Large L (1) and Small L (2). The Large L bracket fastens to 2 – 4 holes on the cover of the antenna. The Large L Bracket may be fastened to the antenna in a variety of positions.

Do not drill into the receiver housing!

7

INSTALLATION OF LASER/RADAR ANTENNA

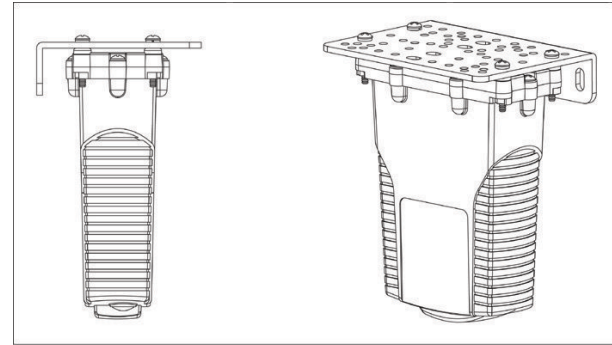

The layout of the holes on the large L bracket accommodates multiple antenna mounting positions.

This arrangement provides flexibility for fastening the antenna/bracket assembly to your vehicle in a manner that allows the antenna window (ANTENNA) to have a forward looking view of the road ahead. The Small L Brackets (2) may also be fastened to the antenna in different positions as shown below:

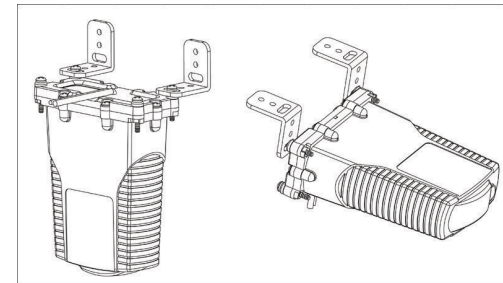

The small L brackets may be fastened to any of the four holes on the antenna

Use one M3 x 20 bolt, washer and nut to fasten each Small L Bracket to the antenna. Again, do not over tighten the screws.

In some situations it may be advantageous to use both the Large L and Small L Brackets to install the antenna in a vehicle.

TIP: Use removable thread lock on the hardware to prevent any bolts from backing out due to vibrations.

8

INSTALLATION OF LASER/RADAR ANTENNA

Large L and small L brackets may be used in combination in a variety of different ways.

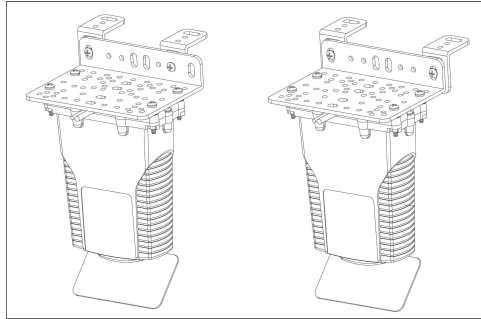

The Small L Brackets are fastened to the Large L Bracket using the #10-32 x 1/2" bolts, #10-32 nuts and lock washers.

To fasten the Large L or Small L Brackets to your vehicle, mark the supporting structure through the appropriate holes in the brackets, and then drill the holes in the supporting structure with a 13/64" drill bit. Attach the bracket(s) to the supporting structure using two bolts (#10-32 x 1-1/4") and corresponding nuts, flat washers, and lock washers. Because rough road surfaces can cause excessive vibration or bouncing, be certain to fasten the bracket(s) securely to your vehicle.

Horizontal or Vertical Mounting Of Antenna

The antenna can be attached to the vehicle in a horizontal or vertical position, or at any angle in between. Select the position that allows you to fasten the antenna to your vehicle in the most secure manner.

Horizontal Mounting - antenna window facing down the road

When mounting the antenna in a horizontal position (or on an angle), remember to keep the ANTENNA window as close to perpendicular as possible to the road surface

INSTALLATION OF LASER/RADAR ANTENNA

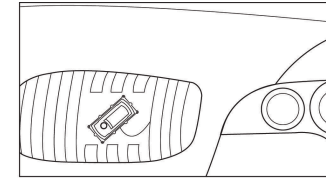

BEST MOUNTING ANGLE FOR OPTIMUM DETECTION OF ALL TYPES OF RADAR GUNS.

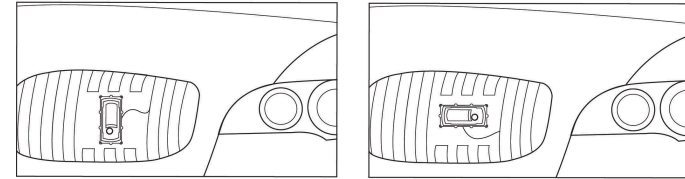

RADAR DETECTOR MOUNTED IN HORIZONTAL POSITION.

(ANTENNA window should not be angled up toward the sky, either side or down toward the road surface).

Vertical Mounting (using the 45° Reflector) - antenna window facing the ground, hood or either fender.

For vehicles that do not have sufficient clearance (about 5") behind the grille to mount the antenna in a horizontal position, the 45°. Reflector should be used.

The 45° Reflector is attached to the antenna with double sided tape on the top of the antenna housing. Clean the surface with isopropyl alcohol and let dry. Peel the protective backing of one side of the double sided tape and place on the recessed area on the top of the laser/radar antenna. Peel off the other side of the double sided tape and then place the reflector onto the antenna. Make sure that the reflector is positioned properly.

INSTALLATION OF LASER/RADAR ANTENNA

Mount the antenna to the vehicle such that the ANTENNA window is facing the road surface, sky, right or left of the vehicle, and the reflector has an unobstructed view of the road ahead.

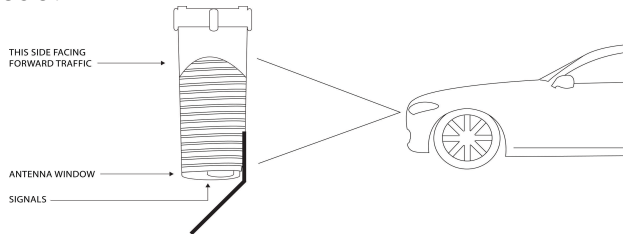

Mounted in this position, laser/radar signals are reflected into the ANTENNA window.

Mounting the Temperature Probe

Find a location that is far enough away from the engine and radiator heat but still in the airflow for the vehicle. Mounting the Probe too close to these heat sources will give a higher than expected result.

- Attach the mountable tie wrap (supplied) to the Temperature Probe as shown.
- Mark location for Probe, and then drill a hole using a #32 drill bit. Attach Probe with tie wrap in the correct orientation using the 3.5 x 16 screw.

NOTE: Mount the Probe so that there is space between the Probe and the mounting area. Do not mount Probe directly to metal area.

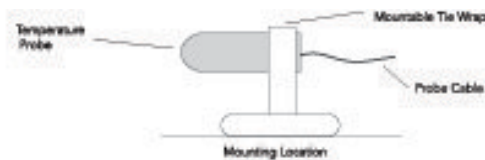

11

INSTALLATION OF LASER/RADAR ANTENNA

Antenna Cable to the Interface Box (iBox)

Once the antenna is installed, connect the antenna cable to the quick disconnect interface cable. The antenna cable and the interface cable have an arrow embossed in each plug. These arrows must line up to properly to connect the cables together.

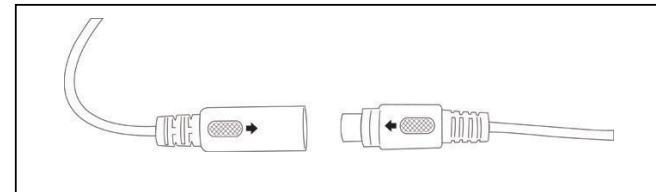

Run the cable along the edge of the engine compartment to the firewall. Find a location in the firewall where other wires (or the speedometer cable) enter the passenger compartment and feed the phone jack connection through. Be careful not to interfere with or disconnect other wires, cables, or mechanical systems of your vehicle while routing the antenna cable. If there is no easy way to route the cable through the firewall, you can drill a 15/32" hole.

IMPORTANT: Check with the vehicle's manufacturer to see if there are any issues with drilling through the firewall.

Caution: When drilling or working around the vehicle's firewall, check the other side for any obstructions that might be damaged.

The interface cable includes a rubber grommet to keep the weather out of the vehicle. Also, keep the antenna cable away from any areas in the engine compartment that may become hot. Cable ties are provided to secure cables at various points in the engine compartment and under the dash.

12

INSTALLATION OF INTERFACE BOX

Mounting the Interface Box (iBox)

The iBox provides a central location for the connection of all available modules.

Installation steps;

- Locate a clear area under the dash that will accommodate the cables and not interfere with the operation of the vehicle.
- Mount the iBox with screws (not supplied) or tie wraps to the selected area.
- Secure the cables to the vehicle or an existing wire harness with cable ties.

Mounting the Alert LED

The Alert LED not only provides additional visual indication of alarms but when selected in option mode, doubles as a faux security alarm LED.

Installation Steps

- Select a location that is visible to the driver as well as from outside the vehicle to give the illusion of a car alarm LED. Note: Use a replaceable panel whenever possible; to restore the vehicle to original conditions in case of sale or return to lease company.
- Drill 1/4" hole in the desired location.
- Press holder into the hole.
- Slide the LED retainer ring over the LED. Insert the LED into the holder from the back side of the mounting location. Slide the retainer ring onto the holder until it latches into place.
- Plug the cable into the LED Port on the iBox.

INSTALLATION OF OPTIONAL LASER ANTENNA

Optional Laser Antenna

The LRM-360 provides both front and rear laser reception. Mount the unit with the 3-lens array facing forward (down the road) and the single lens facing behind. This approach offers the most protection, since you will most often be traveling into a laser signal, rather than away from it when laser speed enforcement is encountered. For effective protection, make sure the laser antenna has an unobstructed view forward and behind, and that it is not placed behind the windshield's metallic sun screens.

Installing the LRM-360

The laser antenna can be mounted to the front windshield using the supplied windshield bracket.

Before using, attach the suction cup and rubber bumpers (2) to the metal bracket. If necessary, you may bend the metal bracket in order to position the laser antenna correctly (3-lens array facing forward, single lens facing behind.)

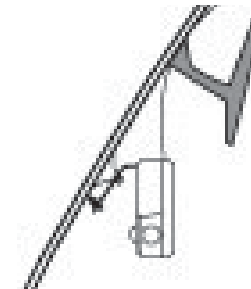

Laser antenna mounted with windshield bracket.

INSTALLATION OF OPTIONAL LASER ANTENNA

Installing the Laser Antenna - Continued

Using Hook & Loop Fasteners, the laser antenna may also be mounted to the back side of your rearview mirror. Be careful not to block the rear facing lens when mounted in this manner. Also, clean the appropriate surfaces with isopropyl alcohol before adhering the adhesive side of the fastener to those surfaces.

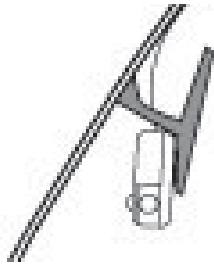

Laser antenna mounted to rearview mirror with Hook & Loop Fasteners.

Laser Antenna Cable Connection

Conceal the cable and plug the phone connector into one of the AUX ports on the iBox.

INSTALLATION OF CONTROL PANEL

Installing the Control Panel

The control panel may be mounted using the through Dash Bracket or supplied double sided tape. When choosing a mounting location, consider the ease of viewing the display, accessibility of controls (remember Mute Mode may be used frequently), and concealment.

The Pro-3600 Control panel can also be mounted sideways and even upside down!

Control Panel Mounted with Double Sided Tape.

Fasteners can be used to mount the control panel to your vehicle. Before adhering the adhesive side of the fastener to a surface, clean that surface with isopropyl alcohol. Use of double sided tape simplifies control panel installation.

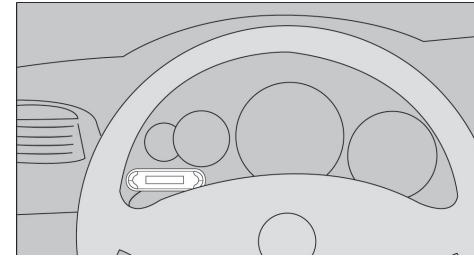

Control Panel Mounted with Through Dash Bracket

Installation instructions are provided on the last page of this manual. We recommend using a professional installer if you are not familiar with customized dashboard installations.

Control Panel Cable Connection

Conceal the cable and plug the phone connector into the DISP port on the iBox.

INSTALLATION OF OPTIONAL MODULES

Voice Module Installation

The Voice Module provides audio for all aspects of modes, alerts and GPS features.

To install:

- Make sure "Voice On" is enabled in Option Mode (default setting). (See Option Mode in owner's manual.)
- For maximum volume, find a convenient location close to the driver's ear, such as the trim panel between A & B pillars. Attach speaker using the supplied clip.
- Run the cable from the location selected to the iBox, so that it doesn't interfere with normal driving operation.
- Plug the cable into the VOICE Port on the iBox. The volume is controlled by the knob on Voice Module.

NOTE: This is the only audio option that can be plugged into the Pro-3600. Any other device may damage the unit and void the warranty.

Optional Rear Laser/Radar Module

For drivers interested in gaining increased detection from behind, the Pro-3600 can be upgraded with a second laser/radar antenna. This antenna is mounted in the back of the vehicle facing rearward and can be purchased from many Whistler retailers or directly from Whistler; ask for the Part Number SWRA-36.

The Pro-3600 iBox is designed to operate with an additional laser/radar receiver; the RADAR2 port is the input for the optional laser/radar receiver. An asterisk is displayed next to the Band ID when laser/radar signals are detected from this module. Must turn RADAR2 on in Option Mode.

INSTALLATION OF OPTIONAL MODULES

Optional GPS Module

The optional GPS module is required to utilize several of the Pro-3600 GPS based features.

These features are:

- Vehicle Speed
- Compass Heading
- Compass Direction Voice Prompts
- Digital Clock
- Red Light/Speed Camera location warnings
- Speed selectable Quiet and Filter modes
- User set speed limit warning
- Trip Time and distance.

Mounting Guidelines

- Unit needs a clear view of the sky above.
- Some windshields have an Instaclear™ or Electriclear™ type coating, that can affect GPS signals. Consult the vehicle's dealer or the owner's manual supplied with the vehicle to determine if the windshield has this coating.

To install:

- Select a location on the dash or center console so that it doesn't interfere with normal driving operation. (remember the unit needs to be able to "see" the sky).
- GPS module has a magnetic base to make installation easy – simply place on a metal area.

Must turn GPS on in Option Mode.

POWER CONNECTION

Power Cable Connection

The iBox has the power cable attached to it. The ground wire has a "U" type connector which should be fastened to a metal surface that is grounded to the vehicle. Look for an existing screw or bolt under the dash to use as a grounding point. The power wire has a spade type connector that can be connected to a switched or non-switched +12 volt DC circuit in your vehicle's fuse box. A switched circuit is one that has power when your vehicle is on, but has no power when your vehicle is off.

NOTE: To utilize the faux security LED option, the iBox should be powered from a non-switched 12 volt source.

ERROR CODES

The codes listed below will be displayed if there is any trouble with the unit.

Please check USB	Problem in communication between USB controller chip and iBox after self-test.
Please check Radar1 communications lines Please check Radar2 communications lines	No communication for at least 5 sec. between Radar1 (or Radar2) and iBox when Radar1 (or Radar2) option is on.
Open Err	No file found to open when downloading Firmware, Voice Data or RLC Data after clicking "NEXT" button.
RDF Err	Unit failed to read file while downloading from the USB Memory
CLF Err	Unit failed to close file after downloading firmware, voice data, or RLC data.
Disk Err	Bad USB disk or not enough USB memory when saving GPS NMEA data to USB memory.
Open Err	Unit failed to create a file when saving GPS NMEA data in USB memory.
ComFail	Unit failed to close a saved GPS NMEA data file.
Please check "X" power line	Possible short circuit or high current in a device plugged into a port on the iBox. The "X" will be replaced with port name in display.

TROUBLESHOOTING

PROBLEM: No display or audio.

- Check fuse in power cable,(4 amp) replace if necessary.
- Check fuse in fuse box, replace if necessary.
- Make sure power cable is properly grounded.

PROBLEM: Unit alarms when using vehicle equipment or electrical accessories (brakes, power mirrors/windows, directionals, horn, etc.)

- Check condition of vehicle's electrical system, including battery and alternator.

PROBLEM: Audio alerts are not loud enough.

- Cancel Auto Quiet Mode or City Mode
- Check audio level settings.
- Check the voice module's volume control.
- Check Speed Selective Auto Quiet Setting if GPS module is connected.

If difficulties occur which cannot be solved by information in this Troubleshooting Guide, please call Whistler Customer Service at 1-800-531-0004 or visit our FAQ page at

www.whistlergroup.com, before returning your unit for service.

For warranty information, refer to owner's manual.

ACCESSORIES

The following accessories can be ordered directly from Whistler by calling 1-800-531-0004 or visit our online store at www.whistlergroup.com

Order Code	Description	Price
RLC-360	GPS Module w/USB Cable	\$ 129.95
SWRA-36	Rear Laser/Radar Antenna	\$ 139.95
LRM-360	Laser Antenna	\$ 39.95

Shipping and handling (per order) \$5.00.

Prices are subject to change without notice.

THROUGH DASH BRACKET

How to install the Console Cradle

1. Copy cut-out template.
2. Carefully remove section marked "CUTOUT".
3. Tape template to desired vehicle mounting location.
4. Trace cutout area.
5. Carefully cut/remove dashboard or vehicle material.
6. Trim "hole" to ensure snug fit of cradle.
7. Insert M4.0x20 mm bolt into cradle.
8. Insert M4.0 nut into Clasp.
9. Place Clasp behind dashboard hole, insert cradle and start to tighten bolt.
10. Ensure all 4 clasp "legs" engage with notches on rear of cradle.

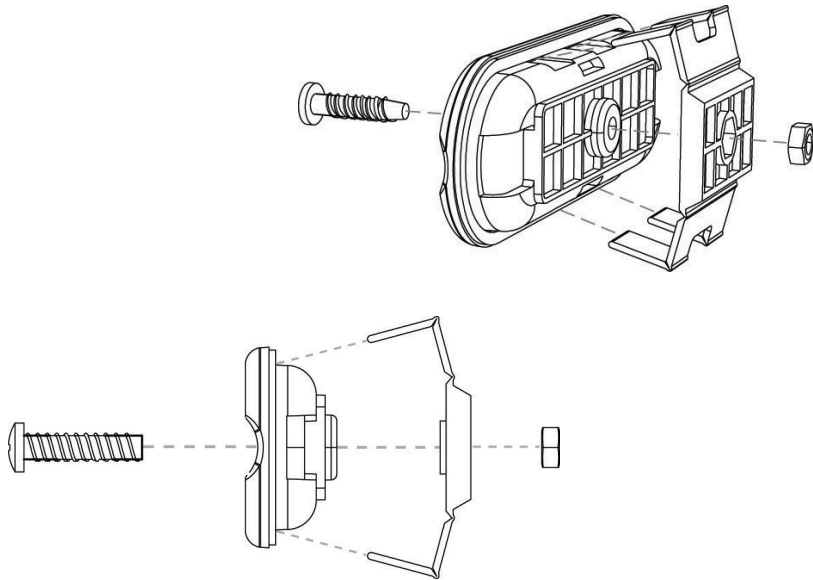

23

THROUGH DASH BRACKET

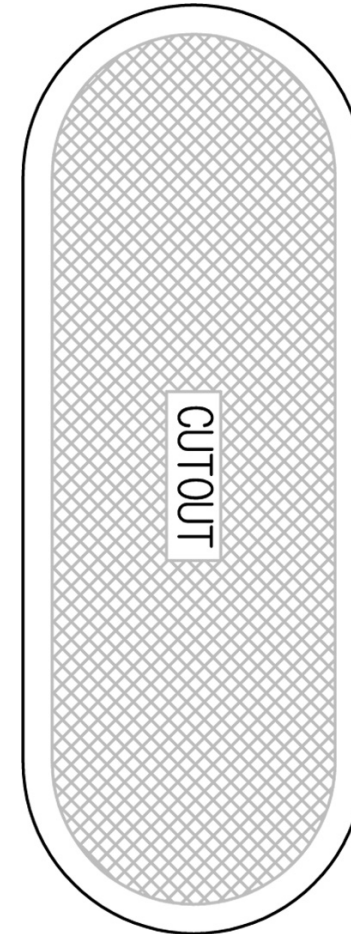

24