

## THANK YOU...

for purchasing the wireless STEEL EYE radar/POP/Laser detector, developed by PNI Corporation.

The STEEL EYE is among a new generation of "superwide" radar detectors that senses police radar signals on all three of the most common radar bands — X, K, and superwide Ka. Plus, it detects the newest police laser and POP devices, both of which are growing in usage nationwide.

This Guide provides all the information you need for putting the STEEL EYE to work for you. For STEEL EYE technical specifications or downloads of the most recent version of this Guide, visit [www.pnicorp.com](http://www.pnicorp.com).

## HOW TO USE THE GUIDE

- = An action to be taken
- = Additional information about the topic

**USE THE QUICK GUIDE** if you are familiar with radar detectors and want to quickly "jump start" your STEEL EYE.

**REVIEW THE COMPLETE GUIDE** if you've never used a radar detector before, or if you have problems operating the STEEL EYE.



## WHAT'S IN THE PACKAGE

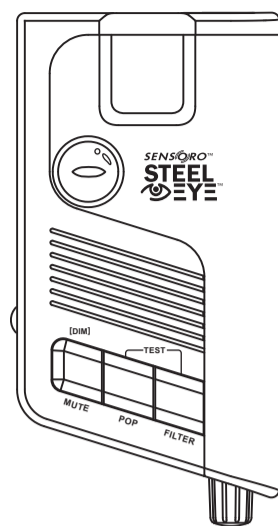

STEEL EYE™ Radar/POP/Laser Detector

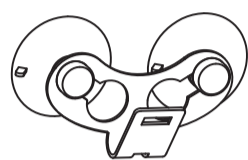

Windshield mounting bracket  
(Shown with suction cups installed)



2 suction cups

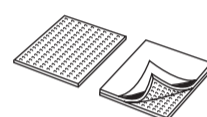

hook-and-loop fastener (1 set)

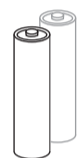

2 AA alkaline batteries

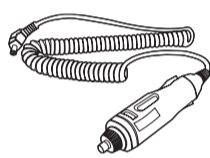

12V DC coiled power cord

If you are missing any of these items, please call us at 1-888-422-6672 and we'll ship them to you immediately.

## QUICK GUIDE

### 1. INSERT THE BATTERIES.

For wireless convenience, use AA alkaline batteries to power your STEEL EYE radar detector:

- Slide open the battery door on the back of the STEEL EYE radar detector.
- Insert two fresh AA alkaline batteries, with the head of the batteries (positive poles) facing in.

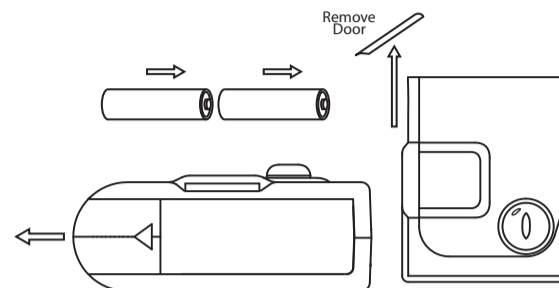

- Slide the battery door closed and shut tight.

### 2. INSTALL ON YOUR WINDSHIELD.

For best performance in detecting police radar signals, install the STEEL EYE on your vehicle windshield:

- Clean a spot on your windshield that will allow easy viewing of both the STEEL EYE screen and the road.
- Bend the mounting bracket as needed to ensure the radar detector will sit level (horizontal) with the road when mounted.
- Insert the suction cups into the bracket.
- Press the suction cups firmly against the windshield until they take hold.
- Attach the radar detector to the bracket.

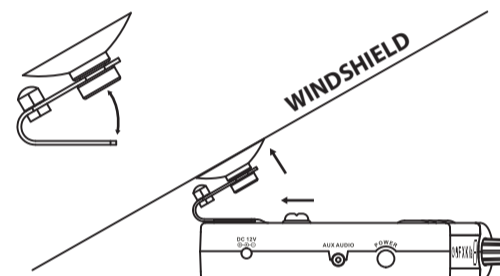

### 3. POWER UP.

- Press the POWER button to turn the radar detector **ON** and **OFF**.
  - The POWER icon or FILTER icon (if the Filter is on) will be lit when the detector is on. If you are using battery power, the icon will blink. If you are using the 12volt power cord, the icons will be continuously lit.
  - If you are using battery power, the radar detector will use the **Auto Shut-off** feature (see **MONITORING YOUR BATTERY POWER**) to conserve battery power, if it is not turned off manually.
  - If you are using the 12V power cord, the radar detector will automatically turn on and off with your vehicle's ignition system, assuming the ignition system controls power to the 12 volt. If the ignition system doesn't control the 12 volt power, you will need to manually control the detector.

### 4. ADJUST SCREEN BRIGHTNESS.

- Press and hold the MUTE button for several seconds to access the DIM mode.
- Release the button to select a screen brightness of 'BRIGHT', 'DIM' or 'DARK'.

### 5. TURN ON FALSE-ALERT FILTER.

The false-alert filter screens out false alerts often caused by automatic door openers, alarm systems, etc.

- Press the FILTER button to turn the false-alert filter **ON** and **OFF**.

### 6. ADJUST THE VOLUME.

Use the Signal Alert Test to adjust the volume BEFORE getting an alert signal:

- Press and hold the POP and FILTER buttons simultaneously for 5 seconds.
  - The screen will display each of the bands monitored by the STEEL EYE, and will sound the audio alarm for each signal alert.
- Increase or decrease the alert volume level by turning the VOLUME control.

## CONTROLS AT A GLANCE

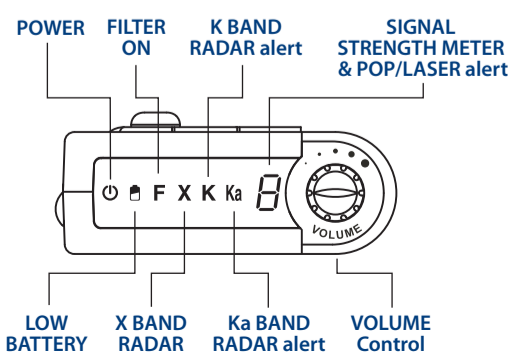
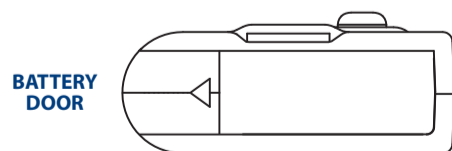
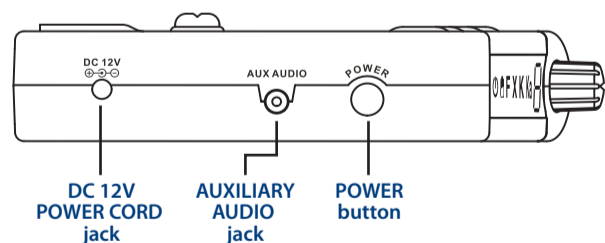
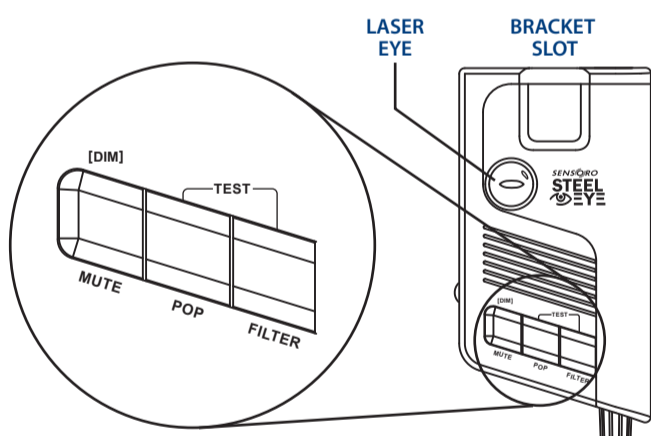

## UNDERSTANDING RADAR BANDS AND SPEED MONITORING SYSTEMS

The STEEL EYE is one of a new generation of "superwide" radar detectors that detects police radar devices operating on all three of the most common radar bands — X, K, and superwide Ka. It also detects police laser devices and POP radar guns, and is invisible to VG-2 radar detector-sensing technology.

### A History of Radar Band Activity

**X Band** — Except for a few early devices, most police radar devices only used the X band frequency (10.50~10.55 GHz) until the mid-1970's. Today this frequency is used by only a small number of police radar devices, as well as many non-radar devices such as automatic door openers and alarm systems. The X band frequency produces most of the false alerts common to radar detectors.

**K Band** — Police radar devices started using the K band frequency (24.05~24.25 GHz) to detect vehicle speed in 1976, leading to the development of the first dual band (X and K) radar detectors.

**Ka Band ("wide-band")** — The introduction of Ka band photo radar (34.3 GHz) in the 1990's led to the development of tri-band radar detectors able to detect X, K and a small portion of Ka bands. As the usable Ka bandwidth expanded, "wide-band" radar detectors emerged, capable of detecting X, K and wide Ka (34.2~35.2 GHz).

**Ka Band ("superwide-band")** — In response to the BEE 36A police radar devices, a new generation of "superwide-band" detectors has been developed, capable of detecting all radar devices operating on X, K and superwide Ka (33.4~36.0 GHz) bands. The STEEL EYE is a superwide band radar detector.

### How Laser Devices Work

Police laser devices transmit an invisible light beam at a wavelength of 904 nanometers. Less than 5% of all speed monitoring devices sold in the U.S. are currently laser devices, but their usage is expected to increase. The STEEL EYE detects all current laser devices in use.

### POP Radar Gun Mode Operation

POP is an instant-on, ultra-fast mode of radar gun operation that uses existing radar frequencies. POP mode can pick up a vehicle speed reading so fast (less than one-tenth of a second) that most radar detectors will not signal an alert. The STEEL EYE can detect POP radar signals under both battery and power cord operation. You may notice a slight increase in Ka-band false alerts when the POP detection mode is turned on, though the STEEL EYE has been designed to minimize these false alerts.

### How VG-2 Technology Works

VG-2 is a technology used by police radar systems to identify vehicles equipped with radar detectors in instances and places where they are not legal (such as in vehicles weighing over 10,000 pounds, or in Virginia and Washington, D.C.). The VG-2 interceptors work by detecting emission frequencies (11.4~11.7 GHz) generated by radar detectors. The STEEL EYE does not produce emissions detectable by VG-2 radar detector-sensing devices.

## STEEL EYE RW3000 FCC ID QJ3-IFS-12418

This device complies with part 15 of the FCC Rules. Operation is subject to the following two conditions: (1) This device may not cause harmful interference, and (2) this device must accept any interference received, including interference that may cause undesired operation. In addition, any changes or modifications to this product, which are not expressly approved by PNI Corporation in writing, could void the user's authority to operate this product.

Model# RW3000

SENSORO™  
**STEEL EYE™**  
RADAR/POP™/LASER  
DETECTOR



## USER'S GUIDE



**PNI Corporation**  
133 Aviation Boulevard  
Santa Rosa, CA 95403  
T: (888) 422-6672 (Customer Service)  
F: (707) 566-2261  
[www.pnicorp.com](http://www.pnicorp.com)



# COMPLETE GUIDE

(See Reverse for Quick Guide)

## 1. CHOOSE BATTERY OR POWER CORD OPERATION.

**BATTERIES** — No dangling cords; neater appearance; blinking display

**POWER CORD** — No blinking display

### 1A. Insert the Batteries.

- Slide open and remove the battery door on the back of the STEEL EYE radar detector.
- Insert two fresh AA alkaline batteries, with the head of the batteries (positive poles) facing in.

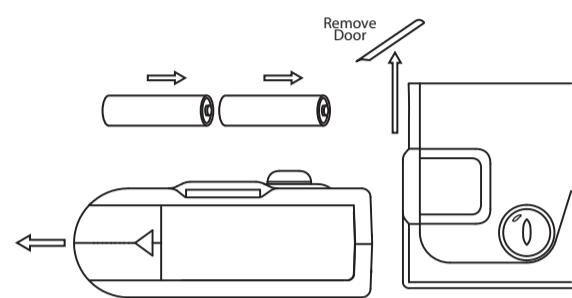

- Slide the battery door closed and shut tight.

NOTE: We suggest keeping your power cord readily available. If your batteries are drained, the cord will allow you to continue using your radar detector until you can replace the batteries.

## 2. SELECT WINDSHIELD OR DASHBOARD MOUNTING.

**WINDSHIELD** — ensures the most accurate and consistent detection of radar signals

**DASHBOARD** — better visibility through the windshield; more discreet appearance

### 2A. Mount on your windshield.

- Remove the paper overlay from the screen.
- Clean a spot on your windshield that will allow easy viewing of both the STEEL EYE screen and the road.
  - NOTE: The back of the STEEL EYE, where the radar receivers are located, should directly face the road in front of you and not be blocked.
- Bend the mounting bracket as needed to ensure the radar detector will sit level (horizontal) with the road when mounted.
- Insert the suction cups into the bracket.
- Press the suction cups firmly against the windshield until they take hold.
- Attach the radar detector to the bracket.

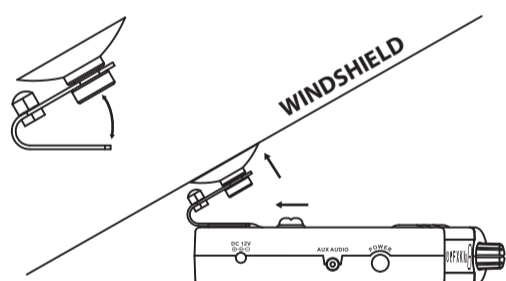

### 2B. Mount on your Dashboard.

- Remove the paper overlay from the screen.
- Clean a spot on your dashboard that allows easy viewing of the STEEL EYE screen.
  - NOTE: The back of the STEEL EYE, where the radar receivers are located, should directly face the road in front of you and not be blocked.
- Peel the backing off one side of the two-piece hook-and-loop fastener and attach the sticky surface firmly to the bottom of the STEEL EYE radar detector.
- Peel the backing from the second side of the hook-and-loop fastener and press the STEEL EYE radar detector firmly to the cleaned area on your dashboard, with the screen facing the rear of your vehicle.

NOTE: For best results, be sure the radar detector is level (horizontal) with the road when it is attached to your dashboard.

## 3. USING AN AUDIO EARPIECE.

You can use the STEEL EYE radar detector with an audio earpiece (for instance, when using the unit on your motorcycle) by connecting the earpiece to the Auxiliary Audio jack.

- Plug a hands-free earpiece (not included with the STEEL EYE) into the radar detector's Auxiliary Audio jack.
  - You will need an earpiece with a 2.5mm (1/10") plug.

## 4. POWER UP.

- Press the POWER button to turn the radar detector **ON** and **OFF**.
  - The POWER icon or FILTER icon (if the Filter is on) will be lit when the detector is on. If you are using battery power, the icon will blink. If you are using the 12volt power cord, the icons will be continuously lit.
  - If you are using battery power, the radar detector will use the **Auto Shut-off** feature (see **MONITORING YOUR BATTERY POWER**) to conserve battery power, if it is not turned off manually.
  - If you are using the 12V power cord, the radar detector will automatically turn on and off with your vehicle's ignition system, assuming the ignition system controls power to the 12 volt. If the ignition system doesn't control the 12 volt power, you will need to manually control the detector.

## 5. ADJUST SCREEN BRIGHTNESS.

- Press and hold the MUTE button for several seconds to access the DIM mode.
- Release the button to select a screen brightness of 'BRIGHT,' 'DIM' or 'DARK.'

## 6. FILTER OUT FALSE ALERTS.

The false-alert filter screens out false alerts often caused in urban areas by automatic door openers, air traffic control systems, alarm systems, and more.

- Press the FILTER button to turn the false-alert filter **ON** and **OFF**.
  - The F icon will light up when the filter is on.
  - The "On" position filters the X radar band, which in addition to police radar, is used for other devices such as automatic door openers, air traffic control systems, alarm systems, and more.
  - Filter "On" is ideal for typical city or highway driving.
  - The "Off" position has no filtering of alert signals.
  - Filter "Off" is ideal for open space areas, and places where X band radar devices are still in use.

## 7. TURN ON POP SIGNAL DETECTOR.

The POP function detects the ultra-fast POP radar gun mode, which is increasingly being used for speed monitoring.

- Press the POP button to turn the POP function **ON** and **OFF**.
  - This screen will display when the POP function is on.



If both the Filter and POP functions are on, the screen will alternate between the POP icon and Filter icon.

- The "On" position monitors a narrow frequency of the Ka band for POP signals.
- When a POP signal is detected, both "Ka" and "P" will light on the screen and an alarm will sound.

NOTE: The POP function significantly decreases your overall battery life. Power cord operation is highly recommended when using the POP function.

## 8. ADJUST THE VOLUME.

Use the Signal Alert Test to adjust the volume BEFORE getting an alert signal. (See the **SIGNAL ALERT TEST** section for a full explanation of this feature.)

- Press and hold the POP and FILTER buttons simultaneously for 5 seconds.
  - The screen will display each of the bands monitored by the STEEL EYE, and will sound the audio alarm for each signal alert.
- Increase or decrease the alert volume level by turning the VOLUME control clockwise or counter-clockwise.

## 9. USING THE MUTE FEATURE.

You may want to mute your STEEL EYE for short periods, such as when you're having a conversation or trying to hear a traffic report on the radio.

- Press the MUTE button to turn it on and off.
  - When pressed **ON**, the Mute feature will remain ON for 1 minute, during which you will not hear any alert signals.
  - The mute feature will automatically turn **OFF** after 1 minute to ensure you continue to receive alert signals.

## 10. MONITORING YOUR BATTERY POWER.

The STEEL EYE includes a LOW BATTERY icon on the display screen.

- The LOW BATTERY icon will light up when approximately 2 hours of battery life remain.
- The icon will flash for 10 seconds, accompanied by several loud audio warnings.
- This will repeat every half-hour until no battery power remains and the radar detector shuts off.

## Prolonging Battery Life

The battery life for the AA alkaline batteries provided in the package is approximately 30-40 hours, based on average usage without the POP function. To prolong AA battery life:

- Never use AA rechargeable batteries as they tend to have a shorter battery life.
- Do not mix old and new batteries.
- TURN OFF the radar detector whenever you leave your vehicle. Even a weak radar signal can cause the radar detector to remain on and drain your batteries.

## Auto Shut-off

(operates with battery power only)

The STEEL EYE will conserve battery power by automatically shutting off after 1 hour if no signal or activity is detected.

- The screen will count down from 9 to 0 during automatic shut-off, accompanied by a beep sound.
  - Press any button during the countdown to keep the radar detector on.

## 11. HOW THE STEEL EYE RADAR DETECTOR WORKS.

When the STEEL EYE detects a police signal, the screen displays the band that the police gun is using — "X", "K", or "Ka" — along with a number indicating the strength of the detected signal (called the Signal Strength Meter).

- There are 9 levels in the Signal Strength Meter — from 1 to 9.
    - The higher the number, the stronger the signal.
    - Usually, stronger signals (5-9) are closer to you than weaker signals (1-4).
  - "L" is displayed in the number field when a laser signal is detected.
  - Both "Ka" and "P" are displayed on the screen when a POP signal is detected.
- Promptly SLOW DOWN if you're driving over the speed limit!

## 12. SIGNAL ALERT TEST

The STEEL EYE includes a test mode for testing and familiarizing yourself with the STEEL EYE visual displays and audio alarms.

- Press and hold the POP and FILTER buttons simultaneously for 5 seconds.
  - The screen will display each of the radar bands (X, K, Ka), along with each of the numbers in the Signal Strength Meter (1-9). Each message will be accompanied by a unique audio alarm.

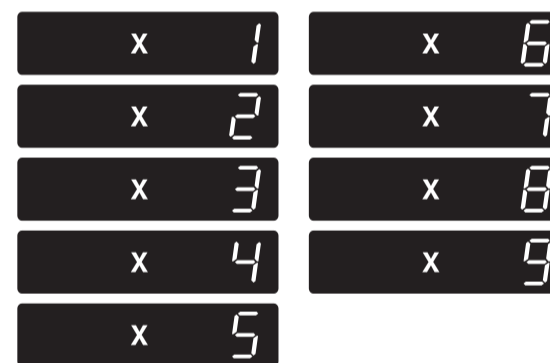

- The screen will then display the POP alert (Ka-P), accompanied by a unique audio alarm.



- The screen will display the laser signal alert (L), accompanied by a unique audio alarm.



- When the test is finished, the screen will illuminate all of the screen icons for 5 seconds, and then revert to stand-by display mode (with only the POWER, FILTER, or POP icon lit until the unit begins to retrieve radar signals).

## SERVICE AND REPAIR

If you wish to return your STEEL EYE radar detector directly to PNI Corporation, contact us between 8:00 a.m. and 5:00 p.m. (PST) Monday through Friday at the following phone numbers or email address. We'll give you instructions for returning your STEEL EYE for repair or replacement.

Phone: (707) 566-2260

Fax: (707) 566-2261

Email: returns@pnicorp.com

# TROUBLESHOOTING

Your STEEL EYE radar detector is designed to provide consistent and reliable service. If you experience any problems, please refer to this section for assistance.

## 1. My STEEL EYE radar detector does not power up when it's operating on battery power.

- Check the batteries and replace them if necessary.

## 2. My STEEL EYE does not power up when it's operating by power cord.

- Check all power cord connections.
- Check the fuse in the 12-volt power cord adapter and replace it if necessary.
  - **Fuse Replacement:** The 12-volt power cord adapter has a replaceable 2-Amp SAG fuse located below the silver tip. To check or replace the fuse:
    - Slowly and carefully unscrew the tip of the plug, making sure the spring and silver tip located inside the plug do not fly out when you remove the cap.
    - Check the fuse and replace it if necessary.

- Check the power outlet in your vehicle and clean if it is dirty.

- Check your vehicle's fuse panel to see if the fuse for the power socket is burned out.

## 3. The STEEL EYE did not alert when passing an officer.

- Check your batteries and power cord connections to make sure your radar detector is receiving power.
  - Note that not all police officers are equipped with a radar/laser device, or their device may not have been in use at that time.

## 4. The STEEL EYE shows erratic or frequent false alerts.

- Use the FILTER-ON mode if you are not currently doing so.

## 5. The STEEL EYE does not alert early enough.

- Make sure the radar detector is level to the road.
- Make sure the radar window and the top laser receiver are not obstructed. Move the radar detector if necessary.

## LIMITED WARRANTY

SHORT SUMMARY OF LIMITED WARRANTY FOR THE STEEL EYE™ RW3000

For the Full Warranty and Limitation of Liability applicable to this product, see our Website at [www.pnicorp.com](http://www.pnicorp.com), select "Consumer Products" and click "Download."

PNI Corporation ("PNI") manufactures its products from parts and components that are new or equivalent to new in performance, and warrants to the original user that this product will be free of defects in workmanship and materials for one (1) year from the date of purchase.

This warranty does not cover wear and tear due to normal use, or damage to the product as the result of improper usage, neglect of care, alteration, accident or unauthorized repair.

If the product is found by PNI to be defective, PNI will repair or replace the product and return the product or its replacement to you at no charge, provided that you ship the product to PNI at your expense with a description of the defect and subject to the other conditions of this warranty. Should the product prove to be irreparable, PNI may substitute an equivalent product of the same or similar style and of a value not in excess of the original purchase price of your unit.

PNI warrants the repaired or replacement product to be free from defects in material and workmanship on the same terms as the product originally purchased.

This warranty will be void if the products, serial number or other identification marks have been defaced, damaged or removed. This warranty does not apply to the battery necessary to operate the product.

This warranty is extended to the original retail purchaser only and may not be transferred or assigned to subsequent owners. In order to validate your warranty, you must provide proof of purchase acceptable to PNI together with the product shipped for warranty repair/replacement.

Products returned to PNI must be pre-authorized by PNI with an RMA (return material authorization) number marked on the outside of the package. Please refer to the Service and Repair section for PNI Corporation contact information.