



EXPRESS

Cordless

RADAR/LASER/SAFETY DETECTOR

2-AA BATTERY OPERATION

X/K/SUPER WIDEBAND Ka DETECTION

TOTAL TRACKING LASER™ (TTL™)

VG-2 GUARD® ALERT

SAFETY WARNING SYSTEM™ (SWS™)

MODEL 946



MOTORCYCLE ACCESSORIES INCLUDED



INTRODUCTION

To ensure maximum benefit from your EXPRESS Cordless, please read all instructions before operating your unit.

Remember, owning a Radar detector does not give you a license to speed. Alerts from a Radar detector serve as an effective reminder to check your speed. Laws vary throughout North America governing the use of a Radar detector. It is your responsibility to follow these laws.

ADVANCED BATTERY POWERED DESIGN

A regulated switch mode and energy conserving circuitry ensure full sensitivity to Radar and Laser over the entire battery life.

SELECTABLE FEATURES

Safety Warning System® (sws™)

EXPRESS Cordless detects encoded signals from sws™ transmitters and provides distinct alerts for: Highway Construction/Maintenance, Highway Hazard Zones, Weather Related Hazards, Emergency/Slow Moving Vehicles and Travel/Convenience Information.

For a complete description of sws™ audio and visual alerts, see page 18.

vg-2 Guard® Alert

EXPRESS Cordless features vg-2 Guard® Alert, which provides an alert to the to the Interceptor vg-2 (Radar Detector Detector).

For a complete description of the vg-2 Guard® audio/visual alert, see page 17.

IDEAL FOR MOTORCYCLE USE

EXPRESS Cordless includes a pocket reflector and an earphone speaker—making it ideal for motorcycle use. (See page 23.)

TABLE OF CONTENTS

Profile of Features ▶ *page 4*

Pre-Operating Instructions

Battery Installation ▶ *page 5*

Auto Shut-Off ▶ *page 6*

Low Battery Warning ▶ *page 6*

Description of Features

Power-Up Test Sequence ▶ *page 6*

Tutorial Mode ▶ *page 7*

Memory Retention of Feature Selections ▶ *page 7*

Adjusting the Audio Level ▶ *page 7*

Audio/Visual Alerts for Instant-On/Pulsed Radar ▶ *page 7*

DRK (Dim/Dark) Button ▶ *page 7*

AUD (Audio Mute) Button ▶ *page 8*

CTY (City/Highway) Button ▶ *page 8*

Reset to Factory Settings ▶ *page 9*

Selectable Features

Entering Selectable Features Mode ▶ *page 9*

Installation

General Guidelines ▶ *page 10*

Understanding Radar, Laser and sws™ ▶ *page 13*

Interpretation of Alerts

Radar Alerts ▶ *page 14*

Typical False Alert (Radar) ▶ *page 16*

Laser Alerts ▶ *page 17*

vg-2 Guard® Alert ▶ *page 17*

Safety Warning System™ (sws™) Alerts ▶ *page 18*

Performance Verification ▶ *page 18*

Troubleshooting ▶ *page 19*

Consumer Warranty ▶ *page 20*

Service

Warranty Service ▶ *page 21*

Post-Warranty Service ▶ *page 22*

Specifications ▶ *page 22*

Accessories ▶ *page 22*

Instructions for Motorcycle Mounting ▶ *page 23*

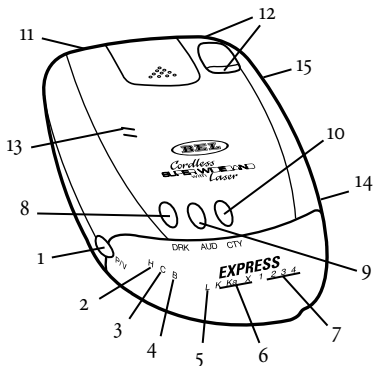

1. **P/V (Power/Volume) Button:** pressing P/V briefly will turn the unit ON. Continuing to press the P/V button will cause the audio level to cycle.
2. **H (Highway Mode) Indicator:** green “H” flashes, confirming EXPRESS Cordless is operating and in highway mode.
3. **C (City Mode) Indicator:** amber “C” flashes, confirming EXPRESS Cordless is operating and in city mode.
4. **B (Low Battery) Indicator:** red “B” flashes in an alternating pattern with either “H” or “C” confirming battery power is low.
5. **L (Laser) Indicator:** red “L” flashes to confirm detection of Laser signals.
6. **K/Ka/X Visual Alerts:** the Radar band received is confirmed by the flashing of the appropriate letter.
7. **4-1ed Display:** the numerals 1, 2, 3 and 4 flash left to right to confirm the strength of Radar signals. Different alert patterns confirm detection of Laser, Safety Warning System® and vg-2 signals.

8. **DRK (Dim/Dark) Button:** provides dim or dark settings of the LED display for discreet night travel. Audio alerts are not affected by this mode.
9. **AUD (Audio Mute) Button:** provides automatic and manual muting of X, K, Super Wideband Ka Radar, Laser and sws™ alerts.
10. **CTY (City/Highway) Button:** minimizes unwanted X band Radar alerts without reducing sensitivity.
11. **Antenna Opening:** Radar signals are received by a patented diecast antenna with integrated transition to microstrip mixer.
12. **Laser Optical Sensors:** collect Laser signals from in front and behind.
13. **Audio Alert Speaker:** all audible alerts are emitted from this location.
14. **External Earphone Speaker Jack:** earphone speaker is connected at this location.
15. **Power Jack:** can be used to insert a power cord, making EXPRESS Cordless operable from your cigarette lighter socket. (See *Accessories*, page 23)

PRE-OPERATING INSTRUCTIONS

Battery Installation

EXPRESS Cordless has been packaged with two AA alkaline batteries to get you started. We advise that you use only alkaline batteries to ensure top performance. Other types may not provide sufficient power output to operate EXPRESS Cordless.

Caution—do not leave EXPRESS Cordless in direct sunlight. Exposure to extreme heat can damage both the battery and unit. Warranty will be void.

To install the battery:

1. With the unit OFF, remove the compartment cover on the underside of the unit by pressing on the raised dots and pushing outwards.

2. A diagram indicating placement of each battery appears at the bottom of the compartment. Gently press the batteries down into place.
3. Replace the battery compartment lid.

Auto Shut-Off

To conserve battery life, if no alerts or button activations occur for approximately one hour, the auto shut-off feature will engage. An obtrusive, 3 second audio/visual warning and an additional 5 second visual warning will confirm the unit is about to shut off. To defeat auto shut-off, press any button during this 8 second warning.

Low Battery Warning

Three warnings alert you as battery power diminishes. The level of battery life remaining is confirmed by the following:

1. **4–2 hours battery life remaining:** *the “B” (battery) LED flashes once followed by the green “H” LED or amber “C” LED flashing three times. This flashing pattern will continue for two hours.*
2. **Less than 2 hours battery life remaining:** *the green “H” LED or amber “C” LED flashes once followed by the red “B” LED flashing three times.*
3. **Final warning:** *red “B” LED flashes continuously coupled with a loud, obtrusive audible warning, confirming a new battery is required.*

Please note—we advise you take EXPRESS Cordless indoors after use during cold weather. In some circumstances, the “B” (battery) LED may flash if the battery is extremely cold. Once the battery warms up however, this situation will be corrected.

DESCRIPTION OF FEATURES

Power-Up Test Sequence

Each time your unit is turned ON, alerts for Laser, K, Ka, X and sws™ (leds 1–4) are presented briefly, followed by the illumination of the “h”, “c” and “b” leds. After this sequence, illumination of led #1 and/or led #2 indicates if Selectable

Features are engaged. (See page 9.) If your unit presents an led illumination pattern other than this standard power-up test sequence, return it to beltronics for servicing.

To bypass the power-up test sequence, press the p/v button twice. Your unit will be ready for operation after indicating status of sws™ (1 led #1) and vg-2 Guard® (1 led #2).

Tutorial Mode

The tutorial mode allows you to become more familiar with all audible and visual alerts. To engage this mode, press the AUD and CTY buttons simultaneously while the unit is ON. The audio/visual alerts will be presented slowly in order of Laser, K, Ka, X, vg-2 Guard® and sws™ followed by the illumination of the “h”, “c” and “b” leds. After the tutorial mode, your unit will be ON.

Memory Retention of Feature Selections

Any time your unit is turned OFF or the batteries are removed, all feature settings are retained in the unit's memory. Memory retention eliminates the need to reset your preferred feature settings each time your unit is turned off and then back ON.

Adjusting the Audio Level

Once your EXPRESS Cordless is receiving power, the audio level can be adjusted by continuing to press the P/V button down. As you hear the audio level change, the numerals 1, 2, 3 & 4 provide a visual reference of the audio level.

To reverse the direction in which the audio level cycles, briefly release, then reactivate the P/V button.

Audio/Visual Alerts for Instant-On/Pulsed Radar

This type of signal appears suddenly when a Radar unit is “triggered”. The instant-on alert consists of an intense, three second, X, K or Super Wideband Ka audio “burst”, coupled with the “ramping” illumination (1–4) of the 4-led display.

DRK (Dim/Dark) Button

The DRK button allows selection of a dim or dark setting for all leds. To engage dim mode, press the drk button once. A single “beep” confirms your selection. To completely cancel the illumination of all leds, press drk a second time. You'll

notice the “H” or “C” indicator remains dim to confirm your unit is receiving power. To return to a full bright setting, press the DRK button a third time; two “beeps” confirm this selection. Use of the DRK button does not affect audio alerts.

Important—if you press the DRK button and do not receive audible confirmation, the audio level has been set too low.

AUD (Audio Mute) Button (Radar, Laser and sws™)

Continuous Audio Alert Pattern

Your unit has been preset at the factory to provide continuous audio alerts at your selected audio level. This standard setting is often preferred when background noise in a vehicle is loud.

Automatic Mute Audio Alert Pattern

To engage automatic muting, press the AUD button once when the unit is receiving no alerts. A single “beep” confirms automatic mute mode has been engaged. The alert pattern when this mode is activated, consists of an initial audio warning at your selected audio level followed by continued warning at a lower audio level. If a new signal is detected within 5 seconds of the previously detected signal, while in automatic mute mode, only the lower level audio warning will be heard. The automatic mute mode enables you to conveniently monitor extended encounters without having to manually mute or adjust the volume setting. To return to the continuous audio alert pattern, press the AUD button a second time (providing no alerts are being detected). Two “beeps” confirm you have cancelled automatic mute mode.

Manual Muting of Audio Alerts

Regardless of the AUD mode selected (continuous or automatic mute), the audio alerts can be completely muted by pressing the AUD button *during an alert*. Once the alert has passed, the unit will revert to the previous aud setting.

CTY (City/Highway) Button

The CTY mode has been designed to effectively reduce unwanted audio alerts caused by intrusion alarms, door openers, and other devices which share X band with police Radar—without reducing sensitivity. Signals from non-police Radar

sources are frequently encountered in urban and suburban areas, making use of this mode ideal in these areas.

Pressing the **CTY** button once engages the **CTY** mode which is confirmed by the flashing amber city LED labeled “C” and a single audio “beep”. Pressing the **CTY** button a second time returns you to highway mode; a single “beep” will confirm this selection. Once engaged, weak X band signals encountered will produce no audible alert until the signal strength reaches a preset level. However, visual alerts are processed the instant an X band signal is detected, keeping you quietly informed. Since most “false” X band signals are weak, the use of the **CTY** mode allows you to drive out of their range before they reach the preset level and trigger a full audio alert. In contrast, signals from X band traffic Radar are generally stronger and will exceed the preset level, causing a full X band audio alert.

Activating the **CTY** mode will not change Super Wideband Ka, K or instant-on X band Radar alert patterns.

Note—the cty mode has no effect on the reception of Laser, sws™ or vg-2 signals.

Reset to Factory Settings

You can reset your unit to factory settings for volume, **DRK**, **AUD**, **CTY** and Selectable Features. With the unit **OFF**, press and hold the **aud** and **cty** buttons simultaneously, then press the **P/V** button. Your unit is now **ON** and ready for operation.

SELECTABLE FEATURES

Safety Warning System™ and VG-2 Guard® Alert are features that may be selected **ON** or **OFF**, depending upon your preference. These selectable features are referenced using LEDs #1 and #2.

Safety Warning System™ (sws™)—LED #1

When activated, unit will detect signals from sws™ transmitters and provide audio/visual warnings. Factory setting is **ON**.

VG-2 Guard® Alert—LED #2

When activated, unit will detect signals from Interceptor vg-2 transmitters, providing immunity to detection. Factory setting is **OFF**.

Entering Selectable Features Mode

1. With the unit OFF, press and hold the CTY button, then press the P/V button. The amber X LED will illuminate and a short “beep” will sound.
2. Immediately after the “beep”, led #1 will show the status of the sws™ selectable feature. To select led #2 (VG-2 Guard®), press the CTY button. Use the CTY button to toggle between the two LEDs.
3. If illumination of the selected led is **solid**, feature is ON, but may be canceled by pressing the AUD button. Two “beeps” will sound, confirming feature is OFF.
4. If the selected LED is **flashing**, the feature is OFF, but may be activated by pressing the AUD button. A single “beep” and **solid** illumination will confirm the feature is ON.
5. Press the p/v button to retain your new settings for selectable features. Two “beeps” will confirm that you have exited from selectable features. Your unit will be ON and ready for operation.

INSTALLATION

General Guidelines

Do not mount your unit directly behind windshield wipers or mirrored sunscreens which block Radar and Laser signals and substantially reduce warning range. Unlike “after market” mirrored sun-screens, regular tinted glass does not affect Radar reception.

Radar signals are also reflected by the “heated windshields” known as Instaclear® and ElectriClear® available as an option on some vehicles. This type of windshield makes any dash, visor or windshield mounted detector ineffective. (If in doubt, check with an appropriate dealership to see if this applies to your vehicle.)

To achieve optimum performance, regardless of which mounting position you choose, follow these basic steps on the following page:

Instaclear is a registered trademark of the Ford Motor Company.
ElectriClear is a registered Trademark of Libbey, Owens, Ford, and Delco-Remy.

1. Consider occupant safety when selecting a mounting location. Choose a location where the unit will not be hazardous in case of an accident.
2. For optimum detection, position your unit with a clear, unobstructed view of the road from the *front and rear*.
3. Do not allow the unit to make contact with the windshield. This will eliminate unnecessary vibration.
4. Avoid placing your unit in direct sunlight. During the summer, interior temperatures of an enclosed vehicle can sometimes reach temperatures that will cause premature aging of the unit.
5. Your detector is not waterproof; exposure to water may cause damage.

Dash Mounting

1. Select an area that is relatively level, clean and dry. Adhere the soft portion of the enclosed hook and loop fastener to this area and the corresponding hard portion to the bottom of your unit.
2. Fasten unit to dash by placing hook and loop pieces together.

Bracket Assembly

1. The visor clip is fully assembled. To assemble the windshield bracket, follow this diagram.

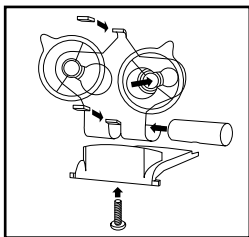

Visor Mounting (Not recommended for Motorcycle use)

1. Remove the detector's cover by pressing on the raised dots and pushing outward. Store the cover in a safe place.

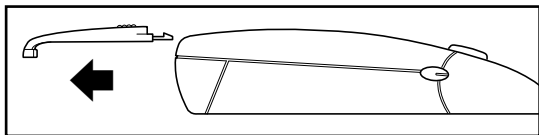

- Slide the visor clip onto the top of the detector until it snaps into place. Clip the detector to the edge of the sun visor nearest the windshield.

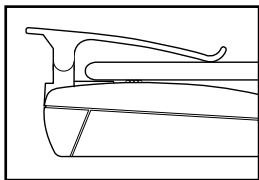
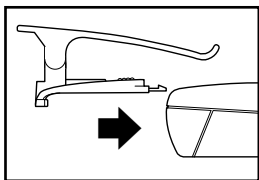

Windshield Mounting (*Not recommended for Motorcycle use*)

- Remove the detector's cover by pressing on the raised dots and pushing outward. Store the cover in a safe place.
- Clean the selected windshield area, position the suction-cup mount on the windshield, and press firmly on each suction cup to secure it in place.
- Use a screw driver or a small coin to adjust the suction-cup mount until the base plate is level.
- Slide detector onto base plate until it snaps into place.

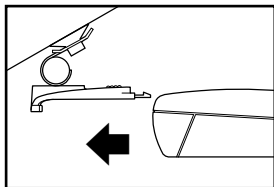
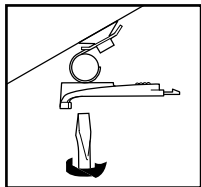

Note—some vehicles have a plastic coating on the inside of the windshield designed to protect occupants in case of an accident. Use of the windshield bracket on this type of windshield can permanently mark the surface. Check with your dealer if you are unsure whether your vehicle is equipped with this type of windshield.

Three Radar Frequencies

Three microwave frequencies have been allocated by the FCC (Federal Communications Commission) and are used for traffic Radar. They are:

X band: 10.525 GHz

K band: 24.150 GHz

Super Wideband Ka: 33.4 GHz to 36.0 GHz

Both X and K bands are well known to motorists who have traveled with Radar detectors. Introduced first was X band Radar which became common during the 1960s. In the mid 1970s the lower powered, more difficult to detect K band Radar was introduced. In 1987, FCC approval was given for Radar equipment using a third frequency, Ka. In response to this, BELTRONICS introduced the first Radar detectors capable of detecting X, K and Ka band signals. In late 1990, FCC approval was given to Wideband Ka: 34.2 GHz to 35.2 GHz. Once again, BEL responded with Wideband Ka detection. Today, EXPRESS Cordless detects the *complete* Super Wideband Ka frequency allotted for police monitoring—33.4 to 36.0 GHz.

Total Tracking Laser™ (ttl™)

Unlike Radar signals, which are highly reflective, Laser signals have very poor reflective characteristics. Many of today's Laser detectors do not have the high sensitivity necessary to detect Laser within a large "field of view". Your EXPRESS Cordless incorporates BEL's number one rated Laser detection. Twin Laser ports detect energy far outside the main Laser beam—including off-axis signals—providing the largest achievable 360° "field of view". The alerts received by your unit are the same whether they are received from the front or rear.

Note—the use of the pocket reflector will provide front Laser detection only.

Safety Warning System™ (sws™)—What is it?

The Radio Association Defending Airwave Rights, Inc. (R.A.D.A.R.) conceived and developed the Safety Warning

System™. The concept behind this system is to warn motorists of potential road hazards by employing Safety Warning System™ transmitting devices in areas such as construction zones, accidents sites and detours. Because these sws™ transmitters operate within the 24 GHz portion of the K band frequency, their signals are detected by your EXPRESS Cordless.

INTERPRETATION OF ALERTS

Radar Alerts

The alerts provided by your unit are affected both by the type of transmission (continuous wave or instant-on), and the position of the Radar source. Generally, when you drive closer to a Radar source, the intensity of the received signal increases, resulting in the flashing of a higher number in the 4-LED display and a corresponding increase in the audio alert rate. Described below are five common types of Radar encounters and the alerts you will typically receive.

Note—during the initial three seconds of an alert, the LEDs will illuminate solid to provide clear indication of the alert received before entering flashing mode.

1. *Stationary or moving Radar, straight ahead aimed in your direction.*

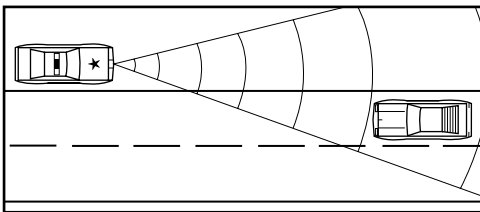

Since Radar signals travel in a straight line, this Radar encounter potentially offers maximum warning range. Once the signal is received, the initial warning consists of the X, K or Super Wideband Ka audio and visual alerts and the simultaneous flashing of digit #1 or digit #2 in the 4-led display. The actual digit displayed will depend upon the strength of

the signal received. As the strength of the Radar signal increases, the audio alert becomes more rapid and the flashing of digit #3 or #4 or the flashing of all LEDs (left to right) will occur. This indicates a maximum signal strength. Assuming the Radar signal remains uninterrupted, the audible and visual alerts will clearly indicate a “weak” signal becoming stronger as you drive closer to the Radar source. Remember, when the police Radar source is moving toward you, the Radar signal strength will increase much more rapidly than if you are approaching a stationary source.

2. *Stationary Radar aimed around a corner*

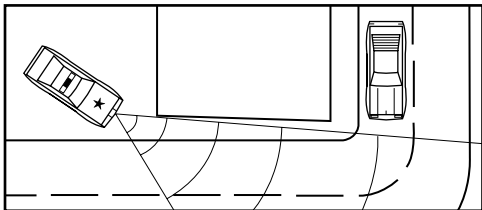

Under this circumstance, reaction time is considerably reduced. Since the Radar signals are transmitted across your line of travel, there is generally no signal available to receive until you are relatively close to the source. Once an alert is received, expect the strength of the signal to increase very quickly. Advanced warning in this situation may be reduced.

3. *Stationary Radar concealed by the crest of a hill aimed in your direction.*

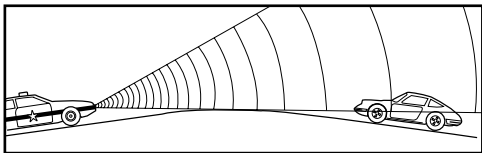

Radar signals travel in a straight line and do not pass through earth. Consequently, police Radar aimed at the crest of a steep

hill cannot be received until you are at or near the top. Warning time may be minimal (as in situation #2) since a strong signal is not present until you are near the crest of the hill. At this point, you may be nearly in the police officer's line of sight. When cresting a hill, a weak initial alert followed very quickly by a full alert is typical. This alert pattern requires prompt attention.

4. *Moving Radar behind you, traveling in the same direction.*

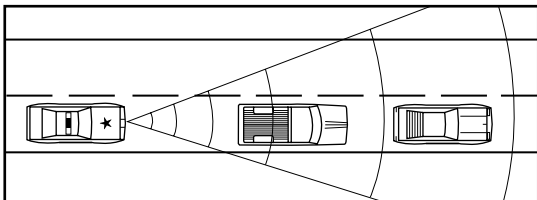

Police Radar signals transmitted from behind your vehicle can be received when reflected by objects in front of you such as large signs, bridges and trucks. As you drive, the size and configuration of these objects are constantly changing causing the strength of any reflected Radar signal received to vary. A strong, uninterrupted alert indicates the patrol car is close behind.

Instant-On Radar

If you are the target vehicle, an alert caused by instant-on Radar will be strong and immediate. When encountered, your unit responds with a three second audio/visual instant-on warning.

Typical False Alert (Radar)

Ideally, a Radar detector should only alert in the presence of police Radar. However, because other devices share X band with police Radar, false alerts sometimes occur. Generally, a false signal produces only a short audio and visual alert. Since they are most often weak, it is possible to drive out of the signal's range very quickly and receive only a brief alert. Although many times the probable source of the false signal can be identified (supermarket, bank, commercial building,

etc.), caution is advised until the source can be confirmed. The X band alert pattern caused by a non-police source can look like the initial alert produced by actual police Radar. For this reason appropriate action is required any time an alert is received.

Laser Alerts

When Laser is detected, the 4-led display will “ramp” from right to left (opposite pattern from that of Radar detection). This illumination pattern occurs rapidly and is coupled with the flashing of the red Laser LED (L) and the Laser audio alert.

If a vehicle is a long distance from the source of Laser pulses, fewer pulses will generally be received. The closer the vehicle is to the source of Laser pulses, the greater the likelihood of receiving a steady stream of Laser pulses. The reason for this is the aiming stability of the Laser gun and the fact that it is impossible to hold the gun absolutely still. Any movement of the gun results in motion of the beam at the target. The further the target, the greater the displacement of the beam and the shorter the dwell time of the beam at the target point. Therefore, there is the possibility of receiving only a few Laser pulses.

Due to these characteristics, all Laser alerts received from your unit should be taken seriously.

vg-2 Guard® Alert

Whenever your express Cordless detects signals from the Interceptor vg-2 (Radar Detector Detector), the vg-2 Guard® Feature alerts (vg-2 Guard® must be selected **on** in Selectable Features, see page 9). A distinct, 3-second audio warning coupled with the flashing of the first and fourth leds in the 4-led display confirm activation of the vg-2 Guard®. The led flashing continues for as long as vg-2 Guard® is activated. During the vg-2 alert your unit does not detect Radar or sws™ signals. However, the presence of the Interceptor vg-2 indicates that traffic is being monitored and your speed should be adjusted accordingly.

Note—activation of vg-2 Guard® does not affect detection of Laser signals.

Safety Warning System® (sws™) Alerts

With the Safety Warning System™ feature on and an sws™ transmitter in use, your detector will provide a unique, 3-second “beep” followed by clicking, coupled with the flashing of the appropriate led in the 4-led display. To select sws™ on or off, see *Selectable Features*, page 9.

LED #1 confirms **Highway Construction/Maintenance ahead**

LED #2 confirms **Highway Hazard Zone Advisory** which could indicate an accident ahead

LED #3 confirms **Weather Related Hazards** such as fog ahead

LED #4 confirms **Emergency/Slow Moving Vehicles** in transit

*When only the sws™ audio warning is provided, the category referenced is **Travel/Convenience Information** or the category is unknown*

PERFORMANCE VERIFICATION

Conditions that Affect Radar Alerts

If you feel your unit is not alerting properly, keep in mind that there are many conditions that influence the intensity or duration of an alert:

1. The police are using instant-on/pulsed Radar, in which case no signal is transmitted until visual contact has been made with your vehicle. For detection of this signal, you must rely on reflected signals from Radar directed at traffic traveling ahead of you.
2. The police Radar unit is positioned perpendicular to the road, around a curve, or just over the crest of a hill, thus, significantly reducing the reception range.
3. The highway traffic between your vehicle and the police Radar source is heavy. This blocks/reflects transmitted signals. The presence of several large trucks between you and the police Radar unit could also significantly reduce reception.

- Rain or humid weather conditions can absorb transmitted signals before they reach your vehicle, again reducing detection range.
- The police Radar unit is not properly tuned and is transmitting outside the X, K or Super Wideband Ka frequency ranges.

Conditions that Affect Laser Alerts

If you feel your unit is not properly alerting to the presence of Laser signals, keep in mind that rain, fog, high humidity and other weather conditions can affect the range that the Laser beam can be detected.

TROUBLESHOOTING

Solutions for Common Problems

If your EXPRESS Cordless is not operating properly, please refer to the outline below.

Problem	Possible Cause	Corrective Procedure
Unit not receiving power	Batteries require replacement	replace batteries
"Poor detection range"	Antenna/lens opening partially blocked	Reposition unit with unobstructed view of road ahead and behind.
	Radar signals unable to pass through windshield	Determine whether your vehicle has a "heated windshield" known as Instaclear® or ElectriClear®, or is covered with a metallic sun screen.
Erratic or frequent alerts	High concentration of non-police X band sources	Use CTY mode
		Review section in this manual on <i>Performance Verification</i>
Partial or no display	Dim or dark mode engaged	Disengage dim or dark mode

If you experience a problem with your unit that is not covered in the previous outline please call, Monday to Friday, 9 AM–5 PM EST, for assistance:

1-800-341-2288 USA

1-800-268-3994 CANADA

CONSUMER WARRANTY

Limited 1-Year Warranty

1. This warranty covers all defects in materials and workmanship. This warranty does not apply if the unit has been subject to physical abuse, improper installation, modification, or if the housing or serial number of the unit has been removed.
2. beltronics manufactures its products using parts and components which are new or equivalent to new in accordance with industry standard practices.
3. The enforceability of this warranty is limited to the original consumer purchaser and is not transferable to, or enforceable by, any subsequent owner.
4. In the event of a defect, malfunction or other failure to conform to this warranty, BELTRONICS will, at its sole discretion, repair or replace the unit at no charge. You are responsible for all shipping costs in connection with warranty service pursuant to this warranty.
5. This warranty commences on the date of retail purchase and shall be effective for a period of one year.
6. There are no express warranties covering the unit other than those set forth in this warranty. All implied warranties are limited to the one-year period of this warranty and no warranties, expressed or implied, extend beyond this one-year period. Some states do not allow limitation on how long an implied warranty lasts, so the above limitation may not apply to you.

7. BELTRONICS will in no event be liable for any consequential, incidental, indirect or special damages (including, but not limited to, lost profits) arising out of or in connection with the use, misuse, or function of the unit. Some states do not allow the exclusion or limitation of incidental or consequential damages, so the above limitation or exclusion may not apply to you.
8. This warranty gives you specific legal rights, and you may also have other rights which vary from state to state.
9. You must provide a copy of a dated sales receipt for your unit in order to receive service under warranty.

SERVICE

Warranty Service

If you feel your detector is not functioning properly please review this manual, particularly the section on *Performance Verification*. If you still feel service is required, please follow the instructions below.

1. To obtain service during the one-year warranty period, **please call the appropriate number below to obtain an RA number and shipping instructions**. Remember to return your detector postage paid, insured and in suitable packaging.

1-800-341-2288 USA
1-800-268-3994 CANADA
2. For your own protection, obtain a proof of delivery receipt. Shipping costs are your responsibility.
3. Enclose with your unit the following information:
 - (a) Your name, complete return address and written description of the problem. (No P.O. BOX please.)
 - (b) A telephone number where you can be reached during regular business hours.
 - (c) A copy of your dated sales receipt.

Post-Warranty Service

The following arrangements apply if the one-year warranty period has expired or you are not able to provide a copy of your dated sales receipt indicating purchase within the last twelve months.

1. Return your unit to the appropriate address under *Warranty Service* and follow steps 1 through 3(b) outlined in that section.
2. Enclose a check with your unit for \$75 US or \$85 Canadian to cover inspection and postage return.

SPECIFICATIONS

Radar Receiver Frequencies: 10.525 GHz (X Band), 24.150 GHz (K Band), 33.4 GHz to 36.0 GHz (Super Wideband Ka)

Operating Temperatures: -4°F to 158°F (-20°C to 70°C)

Power Supply Requirements: 13.8 Volts, 200 mA (if operating from a BEL power cord; see *Accessories*, below)

Radar Antenna Type: Patented Diecast Horn with Integrated Transition to Microstrip Mixer

Maximum Dimensions: 5.3" (L) X 3.1" (W) X 1.8" (H)

Weight: 9.0 ounces

BELTRONICS reserves the right to incorporate design improvements which may not be reflected in the specifications listed in this owner's manual.

ACCESSORIES

If you require any additional accessories, replacement accessories or any accessory which is not included with your unit, call to order or for more information Monday to Friday, 9 AM–5 PM EST. (See the accessories list on page 23.)

1-800-341-2288 USA

1-800-268-3994 CANADA

DESCRIPTION	MODEL NUMBER	COST USA	COST CANADA
Suction Cup Kit (2)	DA-6	\$ 2.95	\$ 3.95
Straight Power Cord (4')	DA-16	\$ 9.95	\$ 11.95
Coiled Power Cord (6')	DA-17	\$ 11.95	\$ 16.95
Power Cord Fuses (2)	DA-19	\$ 3.95	\$ 5.95
Hook & Loop Fastener	DA-20	\$ 2.95	\$ 3.95
Visor Clip & Bracket	DA-49	\$ 9.95	\$ 11.95
Windshield Mounting Bracket	DA-703	\$ 11.95	\$ 16.95
Pocket Reflector	DA-891	\$ 7.95	\$ 11.95
Earphone Speaker	DA-881	\$ 11.95	\$ 16.95
Protective Travel Case	DA-62	\$ 13.95	\$ 19.95
Owner's Manual	EXPRESS CORDLESS	N/C	N/C
<i>Prices subject to change</i>	<i>Shipping and handling extra</i>		

INSTRUCTIONS FOR MOTORCYCLE MOUNTING

Note—EXPRESS Cordless is not waterproof—exposure to water may cause damage. Please remember to protect your unit from the elements.

Pocket Reflector

1. Remove the detector's cover by pressing on the raised dots and pushing outward. Store the cover in a safe place.
2. Position the reflector onto the unit as per the diagram and slide the reflector on to the detector until it snaps into place.
3. Place the detector in pocket as pictured.

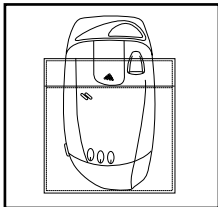
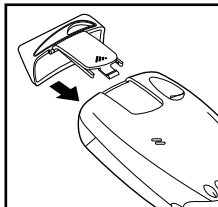

Note—use of the pocket reflector provides front Laser detection only.

External Speaker

The jack located closest to the control panel of the unit is used to connect the external earphone speaker. The earphone speaker is mounted inside your helmet and will ensure you hear all audible alerts.

Note: if you choose to use a power cord with your unit (see accessories, page 23) you must first remove the batteries. This action will prevent damage to the unit.



BELTRONICS™

Head Office

2422 Dunwin Drive
Mississauga, Ontario
Canada L5L 1J9
www.beltronics.com

This product is subject to one or more of the following patents:

U.S.P. #4,571,593	C.P. #1,187,586
#4,630,054	#1,187,602
#4,961,074	#1,295,714
#4,952,936	#1,295,715
#5,402,087	
#5,446,923	

Other Patents Pending

 Fundamental Mixer Technology, FMT and VG-2 Guard are registered trademarks of BELTRONICS. EXPRESS Cordless, Total Tracking Laser, and tt1 are trademarks of BELTRONICS. Safety Warning System and sws are trademarks of Safety Warning System L.C.