

Thank you for purchasing the Wouxun KG-XS20G mobile GMRS radio.

Your feedback makes our products better. Please share your thoughts.

feedback@buywowayradios.com

www.buywowayradios.com

Contents

Safety Information	10
FCC Licensing Information.....	14
Installation and Setup	15
What's Included	15
Transceiver Installation.....	16
Rear Panel.....	17
Connecting a Power Source.....	18
Replacing the Fuse.....	19
Connecting an Antenna.....	20
Optional Connections	20
Hand Microphone Installation.....	21
Getting Started	22
Feature Summary.....	22
Front Panel Guide	24

LCD Guide	25
Hand Microphone	26
Operation.....	27
Introducing GMRS and the KG-XS20G.....	27
Power On/Off.....	28
Adjusting Volume	28
Your First Transmit.....	28
Dual Display: Using Areas “A” and “B”	31
Channel and Frequency Modes	32
Channels and Privacy Codes.....	34
Using the Repeater Channels	35
Channel Scan.....	38
Key Lock	40
Stopwatch Timer	41



NOAA Weather Mode.....	41
Other Functions.....	44
Keypad Hotkeys	48
Function Keys	50
Programmable Function Keys	52
Menu Functions	54
[01: SQL] Squelch.....	54
[02: TX-POWER] Output Power.....	54
[03: W/N] Bandwidth	55
[04: REPEATER] Repeater.....	55
[05: BRT-ACTV] Active Backlight.....	55
[06: BRT-STBY] Standby Backlight.....	56
[07: WX-ALERT] Weather Alert.....	56
[08: BAT-SAVE] Battery Saver.....	57

[09: RX-CTCSS] Receive CTCSS Tone	57
[10: TX-CTCSS] Transmit CTCSS Tone	57
[11: RX-DCS] Receive DCS Code.....	58
[12: TX-DCS] Transmit DCS Code.....	58
[13: BACK-LT] Backlight Timeout.....	58
[14: SCANMODE] Scan Mode	59
[15: SCANGP-A] Scan Group A.....	59
[16: SCANGP-B] Scan Group B.....	60
[17: PRI-SCAN] Priority Scan	60
[18: PRI-CH] Priority Channel.....	60
[19: SCAN-ADD] Scan Add / Delete.....	61
[20: TONESCAN] CTCSS/DCS Scanning	61
[21: TONESAVE] CTCSS/DCS Tone Save Options.....	62
[22: STEP] Frequency Step.....	62



[23: ROGER] Roger Beep	62
[24: TOT] Transmit Overtime Timer	63
[25: TOA] Transmit Overtime Alarm	63
[26: VOX] Voice Activated Transmit.....	64
[27: VOICE] Voice Guide.....	64
[28: BEEP] Button Beeps.....	64
[29: BUSYLOCK] Busy Channel Lockout.....	65
[30: PF1-SHRT] Side Key PF1 Short Press Assignment.....	65
[31: PF1-LONG] Side Key PF1 Long Press Assignment	65
[32: PF2-SHRT] Side Key PF2 Short Press Assignment.....	66
[33: PF2-LONG] Side Key PF2 Long Press Assignment	66
[34: SMUTESET] Secondary Area Mute Setting.....	67
[35: A-MUTE] A Area Mute Setting.....	67
[36: B-MUTE] B Area Mute Setting	68

[37: WORKMODE] Work Mode	68
[38: CH-NAME] Channel Name.....	69
[39: CH-ADD] Add Memory Channel.....	69
[40: CH-DEL] Delete Memory Channel.....	69
[41: COMPAND] Compander	70
[42: SP-MUTE] Speaker Mute	70
[43: ANI-SW] ANI-SW	71
[44: ANI-EDIT] ANI-EDIT	71
[45: SIDETONE] Sidetone Setting	71
[46: ALERT] Tone Alert.....	72
[47: PTT-DLY] PTT-Delay	72
[48: PTT-ID] PTT-ID.....	73
[49: RING] Ring Time	73
[50: CALLCODE] Call Code	73



[51: RPT-TONE] Repeater Tone74

[52: TIMER] Stopwatch Timer74

[53: AUTOLOCK] Auto Lock74

[54: SPK-SET] Speaker Setting.....75

[55: RADIOMEM] FM Radio Memory.....75

[56: RESET] Factory Reset.....76

Advanced Operation 77

 DTMF Encoding77

 Setting Non-Standard CTCSS or DCS78

Troubleshooting 81

Technical Information 83

 Specifications83

 Standard CTCSS and DCS Tones85

 Default GMRS Channels and Frequencies87

NOAA Weather Channels	89
Optional Accessories.....	90
Limited Warranty	91

Safety Information

The KG-XS20G is an electrical apparatus, as well as a generator of RF (Radio Frequency) energy, and you should exercise all safety precautions as are appropriate for this type of device. These safety tips apply to any device installed in a well-designed radio station.

- ⚠ Explosive atmospheres (gases, dust, fumes, etc.). Turn OFF your mobile radio while taking on fuel or while parked in gasoline service stations. Do not carry spare fuel containers in the trunk of your vehicle if your mobile radio is mounted in the trunk area.
- ⚠ Injury from radio frequency transmissions. Do not operate your mobile radio when somebody is either standing near to or touching the antenna, to avoid the possibility of radio frequency burns or related physical injury.
- ⚠ Dynamite blasting caps. Operating the mobile radio within 150m (500 feet) of dynamite blasting caps may cause them to explode. Turn OFF your mobile radio when in areas where blasting is in progress, or where “TURN OFF TWO-WAY RADIO” signs have been posted. If you are transporting blasting caps in your vehicle, make sure they are carried in a closed metal box with a padded interior. Do not transmit while the caps are being placed into or removed from the container.

- ⚠ Never allow unsupervised children to play in the vicinity of your mobile radio or antenna installation.
- ⚠ Be certain to wrap any wire or cable splices thoroughly with insulating electrical tape, to prevent short circuits.
- ⚠ Do not route cables or wires through door jambs or other locations where, through wear and tear, they may become frayed and shorted to ground or to each other.
- ⚠ Do not stand in front of a directional antenna while you are transmitting into that antenna. Do not install a directional antenna in any location where humans or pets may be walking in the main directional lobe of the antenna's radiation pattern.
- ⚠ In mobile installations, it is preferable to mount your antenna on top of the roof of the vehicle, if feasible, so as to utilize the car body as a counterpoise for the antenna and raise the radiation pattern as far away from passengers as possible.
- ⚠ During vehicular operation when stopped (in a parking lot, for example), make it a practice to switch to Low power if there are people walking nearby.

Safety Information

- ⚠ Never wear dual-earmuff headphones while driving a vehicle.
- ⚠ Do not attempt to drive your vehicle while entering frequencies or accessing menu items using the DTMF microphone, front panel or the base unit. Pull over to the side of the road and put the vehicle in park before adjusting or programming the transceiver.

Notice

- These tips are important for safe operation of your KG-XS20G mobile radio and its accessories. If they do not function normally, please get in touch with your dealer immediately.
- If you use components or accessories not produced by the Wouxun Company, Wouxun will not guarantee the safety and usability of the transceiver.

Caution

Please read this manual before using, as it includes important instructions for the safe handling, use and operation of your radio.

FCC Compliance

This device complies with Part 15 of the FCC Rules. Operation is subject to the following two conditions:

- (1) This device may not cause harmful interference, and
- (2) This device must accept any interference received, including interference that may cause undesired operation.

WARNING: MODIFICATION OF THIS DEVICE TO RECEIVE CELLULAR RADIOTELEPHONE SERVICE SIGNALS IS PROHIBITED UNDER FCC RULES AND US FEDERAL LAW.

Safety Information

Radio Operation and EME Exposure

Use only an antenna designed for use with this radio and its operating frequencies. Unauthorized modifications or attachments may damage the radio and violate FCC rules.

DO NOT hold the antenna while the radio is in use.

DO NOT attempt to use the radio with a damaged antenna or feed line.

FCC Licensing Information

The Wouxun KG-XS20G is FCC Part 95E type accepted for use on the GMRS. The KG-XS20G operates on General Mobile Radio Service (GMRS) frequencies according to the Federal Communications Commission (FCC) Rules in the United States. As such, a GMRS license is required to transmit on these frequencies. To obtain an FCC license for the GMRS, please go to the FCC's web site and complete the online application or request FCC Form 605.

What's Included

Carefully unpack the contents of the box and be sure that you have the items in the list below. If any items are missing, please contact your dealer.



Mobile/Base
Transceiver



Hand
Microphone

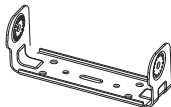

Mobile Mounting
Bracket



Mobile Power
Cord



Screw Sets

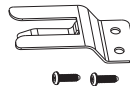

Hand
Microphone
Hook



12V Adapter

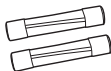

Fuse



User Manual

Transceiver Installation

Choose a safe place inside your vehicle to install the transceiver, considering a location that would not cause harm to passengers while the vehicle is in motion or in case of an accident or sudden braking. Install the transceiver in an area with good ventilation and away from direct exposure to the sun.

1. Use the supplied self-tapping screws to install the support bracket in the vehicle.

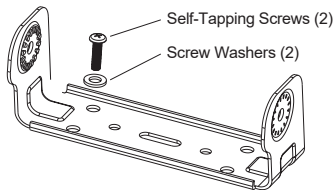

2. Set the transceiver in the bracket, then insert the supplied thumbscrews and tighten, ensuring that the thumbscrews are fastened tightly. This will ensure the support bracket and the transceiver do not become loose when the vehicle hits bumps or shakes.

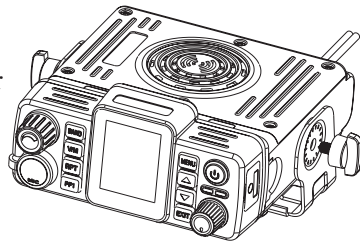

3. The thumbscrews can be loosened to adjust the radio to different angles and then retightened to hold the transceiver in place at that angle.

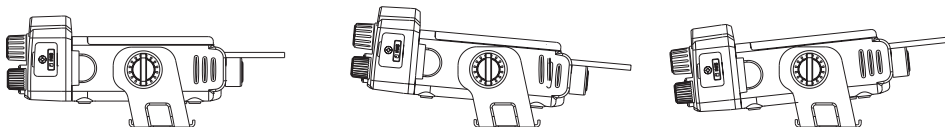

Rear Panel

The connections needed for the installation, programming and operation of the radio are located on the rear panel. Refer to pages 18-21 for information about them.

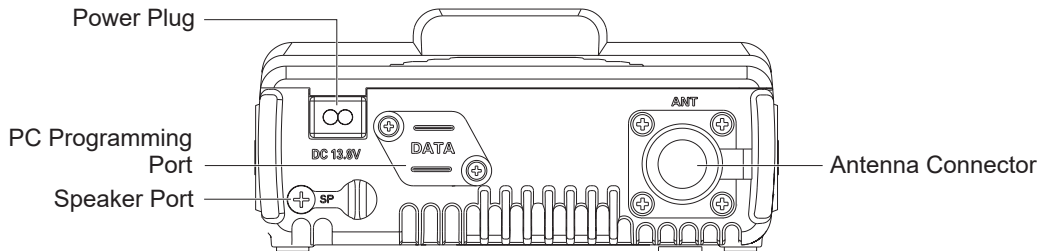

Installation and Setup

Connecting a Power Source

The power requirement of the transceiver ranges from $13.8V \pm 15\%$. If the power source exceeds 16V, TX will be disabled but RX will operate as normal. If the power source falls below 9.5V, the transceiver will automatically shut off to prevent it from draining the battery and affecting the normal operation of the vehicle.

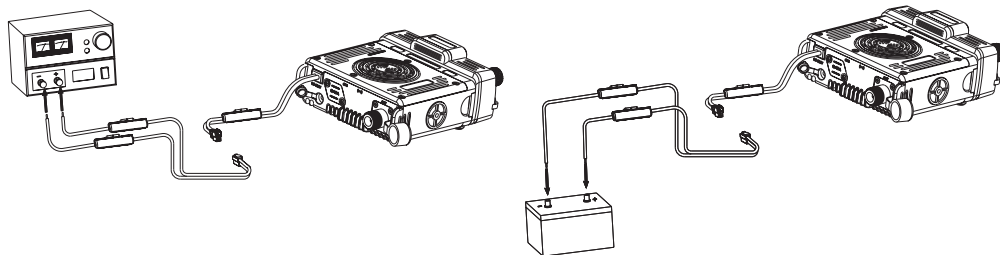

Important

The transceiver's operating voltage is $13.8V \pm 15\%$ DC.

Replacing the Fuse

In the event that the transceiver blows a fuse, first determine the cause, then replace the fuse. If after installing the new fuse it blows again, disconnect the power source immediately and contact your authorized Wouxun dealer for assistance.

The specified fuse current is 15A. The specified power source current is 20A and above.

Refer to the following diagram for fuse installation. Be sure the fuse is properly seated and secured to the copper set.

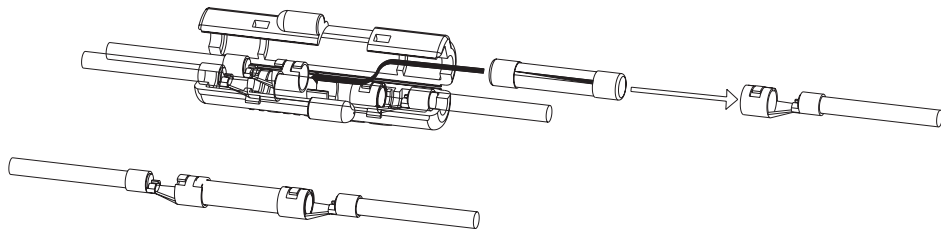

Connecting an Antenna

Before using the transceiver, you must correctly connect a properly tuned and installed antenna. To get the best results, be sure the antenna is tuned for the frequencies that you intend to use, and the antenna's impedance is 50 ohms. **Using an incorrect or improperly installed antenna could harm the transceiver. Never attempt to transmit without an antenna connected!**

The transceiver is equipped with an SO-239 (UHF female) antenna connector. It will require an antenna cable with a PL-259 (UHF male) connector.

Optional Connections

12V Vehicle Power Adapter

The KG-XS20G includes a 12V vehicle power adapter for use as an alternative to the hardwire installation. **Note: The KG-XS20G typically draws less than 4.5 amps of power when in use on high power. Confirm that your vehicle's accessory port uses a minimum 10 amp fuse before attempting to use the 12V power adapter.**

External Speaker

The KG-XS20G is equipped with a 3.5mm external speaker jack on the back of the transceiver. It will accommodate a standard 8-ohm external speaker with a single pin 3.5mm mono audio plug. Stereo plugs will only produce audio from one speaker. Audio accessories with TRRS plugs are not recommended.

PC Programming Port

The KG-XS20G has an RJ45 data port on the rear panel of the unit for use with an optional PC programming cable such as the Wouxun Mobile Radio USB Programming Cable (PCO-003). To access the data port, loosen the two screws and remove the protective cover. Refer to the illustration on page 17 for the exact location of the port.

Hand Microphone Installation

The hand speaker microphone port is located on the lower left side of the front panel. To connect the hand mic to the transceiver, plug the 8-pin connector into the port and tighten the screw ring all the way onto the connector. Do not overtighten.

Feature Summary

- 30 GMRS Channels
- 8 Built-In GMRS Repeater Channels
- Up to 20 Watts Output Power
- Built-in NOAA Weather Channels
- NOAA Weather Alerts
- Tune Specific Frequencies Directly (Frequency Mode)
- Simultaneous Dual Channel Receive
- Color Dual Channel Display
- High/Low Power Selectable
- Wide/Narrow Bandwidth Selectable
- Up to 999 Custom Channels
- Standard and Non-Std CTCSS/DCS
- Split CTCSS/DCS Tone Support
- CTCSS/DCS Tone Scan
- Channel Scan
- Priority Channel Scanning
- Supports 10 Scan Groups
- Multiple Speaker Output Settings
- External Speaker Support
- Display Channel Name, Number, or Frequency
- FM Radio Mode
- 2 Programmable Keys
- Voltage Display
- DTMF Hand Microphone with Speaker, TX/RX Indicator and Volume Control

- Receive (RX) Frequency Range:
 - 136-174.995 MHz
 - 400-479.995 MHz
- Transmit (TX) Frequency Range:
 - 462.550-462.725MHz (GMRS Channels 1-7 and 15-22)
 - 467.550-467.725MHz (GMRS Repeater Channels 23-30)
- Single Tone Pulse Frequency
- DTMF Encode/Decode
- Group Call/All Call/Select Call
- Incoming Caller ID Display
- Comander
- Stopwatch Timer
- English Voice Guide
- Minimum Operating Voltage Settings

Getting Started

Front Panel Guide

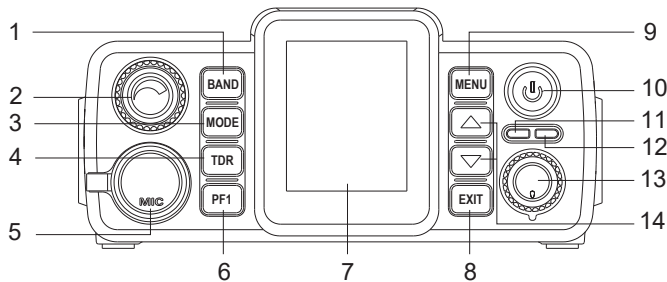

1. Band Key (Page 32)

2. Volume Knob

3. Mode Key (Page 32)

4. TDR Key (Page 31)

5. Hand Microphone Port

6. PF1 Key (Page 52)

7. LCD Display

8. Exit / Cancel Key

9. Menu / Enter Key

10. On / Off Button

11. TX LED (Red)

12. RX LED (Green)

13. Frequency / Channel Knob

14. Up/Down Keys

A full description of each front panel function key is located on Page 50.

LCD Guide

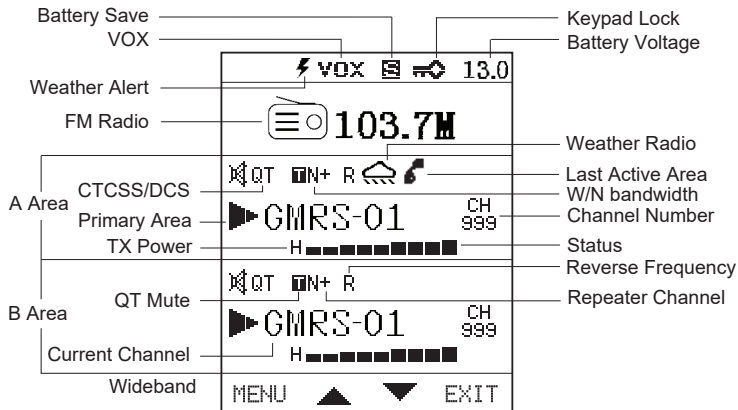

Hand Microphone

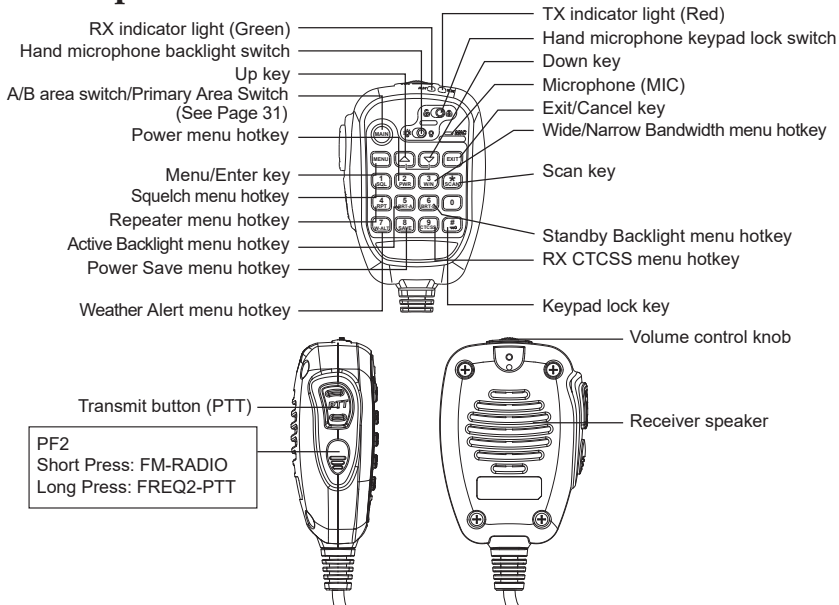

Introducing GMRS and the KG-XS20G

The General Mobile Radio Service (GMRS) is a two way radio service that offers some powerful benefits. Users are allowed to transmit at high power, up to 50 watts, and use advanced equipment such as repeaters that enable you to transmit over large areas. The GMRS requires the user to purchase a license, and a single license covers the user and their extended family for 10 years.

The KG-XS20G was designed to allow you to take advantage of all that GMRS has to offer and more. Right out of the box this radio is configured to allow you to transmit on the 15 high powered GMRS simplex channels, as well as the 8 repeater channels. (Channels 8-14 are only authorized for very low output power on portable handheld radios and are not authorized for transmit on mobile radios by the FCC.) NOAA weather mode is available at the touch of a button, as well as an FM radio.

Read this chapter to learn the basics of using your new KG-XS20G radio, such as selecting a channel, transmitting and receiving, using the dual display, scanning, and using frequency mode. Before continuing, be sure your radio is powered on and connected to an antenna!

Power On/Off

Press and hold the Power button for 3 seconds to power on the radio. To power off the radio, Press and hold the power button until the radio shuts off.

Adjusting Volume

The volume knob is located on the upper left side of the front panel. To adjust the volume, use the volume knob when the radio is powered on. Turning the knob clockwise increases the volume, counter-clockwise decreases it.

Your First Transmit

Selecting a Channel

When you power on your KG-XS20G for the first time, the display will likely show “GMRS-01” in the center with “001” on the right side. GMRS-01 is the name of the currently selected channel. 001 is the channel number. Turn the Channel Knob located on the right side of the front panel or press the [UP] / [DOWN] arrow keys to navigate

through the list of channels.

As a licensed GMRS user you are allowed to use any of the channels. The channel you choose isn't as important as making sure it's the same channel the rest of your group is using. Be sure the channel you select is also supported by the equipment everyone else in your group is using.

Most rules for GMRS are the same for all channels, but there are a few differences, particularly concerning output power. The GMRS channels on the KG-XS20G consist of 4 groups, with the following differences:

- Transmitting on GMRS channels 1-7 is limited to 5 watts of output power. These channels can only transmit at Low power (5 watts) on the KG-XS20G.
- Transmitting on channels 8-14 is limited to a half watt of output power. The KG-XS20G is not capable of transmitting at this low of power and the FCC does not allow transmitting on these channels using mobile radios (although you can listen). Prior to FCC changes made in 2017, these channels were part of the FRS service only and were not available for GMRS.

Operation

- Transmitting on channels 15-22 is allowed at High power on the KG-XS20G. These channels are authorized for up to 50 watts of output power. Prior to FCC changes made in 2017, this group was exclusive to GMRS (not part of FRS).
- Channels 23-30 receive on the same frequencies as channels 15-22, but transmit on a special offset frequency set aside for repeaters. The maximum transmit power allowed on any of the 8 GMRS repeater channels is 50 watts. See page 35 for more information about using the KG-XS20G with repeaters.

Transmitting and Receiving

With a channel selected, the radio is actively “listening” for an incoming signal on that channel. When a signal is detected, the transmission will be heard through the radio’s speaker. Please note, the Squelch setting (page 54) determines how strong a signal needs to be in order to be detected.

To transmit, first be sure the channel is clear and then hold the hand microphone a few inches from your mouth. Hold down the PTT button on the side of the microphone while talking and release the PTT when finished.

Dual Display: Using Areas “A” and “B”

The KG-XS20G is two radios in one! The dual display function allows you to monitor two channels at the same time. While this may sound complex, the KG-XS20G is designed to make this powerful feature easy to use.

The display is divided in half with the top half referred to as “Area A” and the bottom half referred to as “Area B”. Each area controls a separate radio. The current primary area will be the active area. An arrow indicator will appear on the left side of the frequency or channel to indicate which area is primary. When you perform an operation on the radio, such as changing channels or transmitting, that operation is performed on the currently active area.

Turning the Dual Display On and Off

The dual display is off by default on the KG-XS20G. Instead of a frequency or channel name, the text “KG-XS20G” will be displayed in the inactive area when the dual display is off. Use the [TDR] key on the front panel or long-press the [MAIN] key for 2 seconds on the hand microphone to toggle between a single and dual display.

Operation

Changing the Primary Area

With Dual Display on, press the [BAND] key on the front panel or the [MAIN] key on the hand microphone to switch the primary area.

With Dual Display off, pressing the [BAND] or [MAIN] key will switch the currently active area as well, but will also turn off the previously active area. For example, with Area “A” on and Area “B” off, pressing [BAND] or [MAIN] would turn on Area “B” and turn off Area “A”.

Important!

When the A or B area of the screen displays an “▶” icon, it indicates that area is the Primary side and the other area is the secondary side. This is very important to remember, as all of the active operations will be performed on the Primary side.

Channel and Frequency Modes

The KG-XS20G supports tuning frequencies via two methods: channel and frequency

modes. The [MODE] button switches between channel and frequency modes.

In channel mode, frequencies that have been saved can be selected from the channel list. This is the default mode and is the most convenient way to access commonly used frequencies. The KG-XS20G is pre-configured with 30 GMRS channels, but allows users to save custom channels as well (up to 999). In channel mode, turning the Channel/Frequency Knob or pressing an arrow key will tune to the next channel in the list.

Frequency mode (also referred to as VFO mode) allows you to tune directly to a specific frequency regardless of the frequency having been previously saved. In frequency mode, turning the Channel/Frequency Knob or pressing an arrow key will tune to a higher or lower frequency. The STEP menu option (page 62) allows you to adjust the step between each frequency. To enter a frequency directly, type the frequency using the keypad.

The KG-XS20G supports the following frequency bands:

KG-XS20G Frequency Bands	
136.000 - 174.995 MHz	400.000 - 479.995 MHz

Operation

The KG-XS20G can only transmit on GMRS frequencies. All other available frequencies entered in Frequency mode or through the programming software are receive only.

Channels and Privacy Codes

The KG-XS20G supports 30 built-in GMRS channels and 155 privacy tones and codes. To successfully communicate between your stations or members of your group, all the connecting radios must be using the same channel and privacy (CTCSS or DCS) code.

The KG-XS20G supports both standard and non-standard CTCSS tones and DCS codes. These tones and codes can be enabled and configured in the [RX-CTCSS], [RX-DCS], [TX-CTCSS] and [TX-DCS] menu options (pp 57-58). Instructions for entering non-standard tones and codes can be found in the Advanced Operations section of this manual (page 78).

Reminder

The KG-XS20G will only transmit on GMRS frequencies authorized for 5 watts and higher. Band and frequency support for other frequencies is provided for listening only.

The KG-XS20G supports 999 customizable memory channels. Channels can be added, deleted or reordered via the PC programming software.

Using the Repeater Channels

The KG-XS20G is pre-configured with 8 GMRS repeater channels. The channels are named RPT-15 through RPT-22.

What is a Repeater?

In basic terms, a repeater is a device that is used to increase the range of two way radios. Repeaters will receive a transmission on one frequency and simultaneously rebroadcast that transmission on a different frequency. Repeaters are often set up in a fixed location and connected to an antenna that is mounted at a higher elevation to provide better range than is normally available with radio-to-radio (simplex) communications.

Locating a Repeater

Using GMRS repeaters can significantly increase the range of your radio, but just tuning to one of the repeater channels isn't necessarily going to work. You first have to be

Operation

sure there is a repeater listening on that channel's frequency, and you have to be within range of that repeater.

The best resource for locating GMRS repeaters is the website www.myGMRS.com. This site has an extensive database of GMRS repeaters throughout the United States. It is important to keep in mind that a GMRS repeater is not necessarily intended for public use. They are owned by individuals and are sometimes intended for private use or require permission to use.

Before connecting to a GMRS repeater, be sure that you have permission or that the owner is fine with public use. The description on the myGMRS website usually indicates if permission is required and provides a way to get in touch with the owner.

KG-XS20G Repeater Channels

RPT-15 through RPT-22 have the same receive frequency as channels GMRS-15 through GMRS-22. However, the transmit frequency for these channels is assigned to a frequency specifically designated as a GMRS repeater input frequency. The chart below lists the default frequencies for these channels.

Number	Channel	Receive Frequency	Transmit Frequency
023	RPT-15	462.5500	467.5500
024	RPT-16	462.5750	467.5750
025	RPT-17	462.6000	467.6000
026	RPT-18	462.6250	467.6250
027	RPT-19	462.6500	467.6500
028	RPT-20	462.6750	467.6750
029	RPT-21	462.7000	467.7000
030	RPT-22	462.7250	467.7250

Accessing a Repeater in Frequency Mode

The REPEATER menu option (page 55) allows you to transmit to a repeater while in Frequency Mode. If you are tuned to a GMRS receive frequency that is valid for repeater use and turn the REPEATER menu option ON, the radio will transmit to the repeater input frequency when PTT is pressed. The REPEATER menu option is ignored when the radio is not tuned to one of the 8 GMRS repeater transmit frequencies.

Channel Scan

The [*SCAN] key controls the scan function. To activate Channel Scan, press and hold the [*SCAN] key for two seconds or until you hear “Scan Begin”. The radio will scan each channel for activity, starting from the current channel.

Pressing the [UP] / [DOWN] keys while scanning will change the direction of the scan from low to high ([UP]) or high to low ([DOWN]). Press any other key to stop the scan. Refer to the Scan Mode menu item (page 59) for more information on the types of scans available.

The scan function can also be assigned to the PF1 or PF2 button from the menu (pp. 65-66).

Priority Channel Scan

The KG-XS20G supports Priority Channel Scanning. With this feature a priority channel can be specified that is scanned much more frequently than other channels. This helps prevent missing all or part of a transmission when you are primarily con-

cerned with a single channel.

Priority Channel Scanning works by scanning your priority channel in between all other channels. For example, if your priority channel is 3 the radio would scan your channel list in the following order:

1 ▶ 3 ▶ 2 ▶ 3 ▶ 3 ▶ 3 ▶ 4 ▶ 3 ▶ 5 ▶ 3 ▶ ...

To set a priority channel, use the Priority Channel menu item (page 60). To activate the Priority Channel Scanning feature, use the Priority Scan menu item (page 60). Individual channels can be added or removed from the scan list using the Scan Add menu option (page 61).

Scanning CTCSS / DCS Codes

The KG-XS20G is equipped with the ability to scan an incoming signal for a CTCSS or DCS tone and update the current channel's tone settings once the tone is identified.

To activate CTCSS / DCS scan, press the [MENU] key and navigate to the TONES-CAN menu item. Press [MENU] again to enter the menu item and start the scan.

Operation

The scan will begin when a signal is received. The scan will stop when the signal ends and resume from where it left off the next time the signal is received, until it identifies the correct tone.

Use the [UP]/[DOWN] arrow keys to scan in a different direction. Use the [PF2] side key to toggle between scanning the standard CTCSS, positive DCS, and negative DCS tone list. See the TONE-SCAN menu item (page 61) for more information.

Important

TONESCAN must be activated while a signal is being received on the channel.

Key Lock

The buttons on the KG-XS20G can be locked to prevent them from being accidentally pressed. When the Key Lock is enabled, all buttons except the [PF1], [PF2], [#LOCK] and PTT keys will be disabled. The Channel knob will also be disabled.

To activate the Key Lock, press and hold the [#LOCK] key for two seconds. The key

icon will appear at the top of the display. The buttons are now disabled.

To disable the Key Lock, press and hold the [#LOCK] key for two seconds. The key icon will disappear from the top of the display. The buttons should now be enabled.

Stopwatch Timer

The KG-XS20G has a built-in stopwatch timer. It can be enabled using the TIMER menu option (page 74). Once enabled, Press [#LOCK] on the radio to activate the timer. Press any key or turn the channel knob to stop the timer. When stopped, press [#LOCK] to clear and restart the timer, or press any key to deactivate the timer and return to standby mode.

The timer will stop and the radio will exit timer mode if a signal is received on an active channel.

NOAA Weather Mode

NOAA Weather Mode allows you to quickly access weather information from a local NOAA broadcast station.

Operation

To activate NOAA Weather Mode, hold down the [BAND] key for 2 seconds. The display will change to show a NOAA broadcast station frequency starting with 162 MHz and a rain cloud icon will appear above it to indicate the radio is in Weather Mode. Use the Channel/Frequency Knob or the arrow keys to navigate to your preferred NOAA station. Your most recently selected station will be remembered each time you enter this mode.

The Weather Mode function can also be assigned to the [PF1] or [PF2] key from the menu (pp. 65-66). A list of supported NOAA frequencies is included in the Technical Information chapter of this manual (page 89).

Weather Scan

Press the PTT or hold the [*SCAN] key for 2 seconds to scan all of the NOAA weather channels. The scan will stop when an active weather channel is found. Press any key to manually stop the scan. The weather scan is only available in Weather Mode.

Weather Alert

The KG-XS20G features a Weather Alert option (page 56). The Weather Alert

monitors the currently selected weather frequency for a 1050Hz subaudible tone that indicates a weather warning or alert has been issued.

When the Weather Alert is enabled, the radio will scan a regular channel and then a weather channel. If Priority Channel Scan (page 60) is enabled, the radio will first scan a regular channel, then a weather channel, then the priority channel, in that order.

If the 1050Hz alert tone is detected, the radio will stop scanning and produce an alert. Press the PTT to acknowledge the alert and the radio will activate the weather channel.

To exit Weather Mode, press and hold the [BAND] key for 2 seconds. The radio will return to the last channel or frequency accessed.

To locate the NOAA station closest to your location, visit the following site:

https://www.weather.gov/nwr/station_listing

Operation

Note

- Weather Mode is accessible on Area A only.
- While in Weather Mode the menu is not accessible and the radio will receive but not transmit on Area A.

Other Functions

Talk Around

The Talk Around function allows the radio to transmit and receive on the output frequency of a repeater, essentially letting you bypass or “talk around” the repeater. This feature is useful when the repeater is nearly out of range, is not operational, or if you are in range of other stations and would prefer to contact them via simplex. The Talk Around function can be assigned to the PF1 or PF2 buttons from the menu (pp. 65-66).

Reverse Frequency

When Reverse Frequency is activated, the transmit and receive frequencies of the active channel are exchanged or reversed, allowing the radio to transmit on the receive frequency and receive on the transmit frequency. This feature is useful for checking if you are within simplex range of other units before activating Talk Around.

Press the [*SCAN] key on the active channel to activate or deactivate this feature. When activated, an “R” icon will appear above the channel name, frequency or number. The Reverse Frequency function can also be assigned to the PF1 or PF2 buttons from the menu (pp. 65-66). Available in Channel Modes only.

SOS

The radio can transmit an SOS alarm to other stations on the same channel. When SOS is activated, the radio will emit an oscillating alarm. After 2 seconds, the radio will transmit the alarm. To activate the SOS function, it must first be assigned to the [PF1] or [PF2] key (pp. 65-66).

Alarm

The radio features an alarm function with an ANI ID code. When activated, the radio will emit an oscillating alarm and transmit an ANI ID code plus the numbers “110” on the active channel for 10 seconds. After 5 minutes, the alarm will repeat. Press any key to deactivate the alarm.

To activate the alarm function, it must first be assigned to the [PF1] or [PF2] key (pp. 65-66).

Selective Call

This function allows you to send a call to a specific calling group. When Select Call is assigned to one of the programmable keys, pressing the key will automatically transmit the pre-programmed PTT-ID of the select group so you don't have to key it into your keypad manually when you begin to transmit. Call groups are set in the [CALL-CODE] menu option (page 73). The selective call function [SELEC CALL] can be assigned to the PF1 or PF2 buttons from the menu (pp. 65-66) or through the programming software.

Secondary Frequency PTT

The KG-XS20G features an alternate push-to-talk (PTT) button that transmits on the secondary area. For example, if Area A is primary, using the alternate PTT will transmit on Area B. This is useful when monitoring traffic on two separate channels and you want to transmit on both without having to change the primary channel. The secondary frequency PTT function [FRQ2-PTT] can be assigned to a long press of the PF1 or PF2 buttons from the menu (pp. 65-66) or through the programming software.

FM Radio

The KG-XS20G features a 76.02-108MHz commercial broadcast FM Radio. To access the FM Radio, it must first be assigned to the [PF1] or [PF2] key (pp. 65-66).

When active, the current FM radio frequency will appear near the top of the display above Area A. To find an active broadcast station, press [*SCAN] to begin the FM Radio scanning function. Press any key to stop the scan.

Up to 20 FM radios stations can be stored on the radio using the [RADIO-MEM] menu option (page 75).

Operation

Monitor

The MONI function opens squelch on the currently active area allowing you to listen to all traffic on the current frequency. This is useful for listening for weak transmissions. To use the MONI function, it must first be assigned to the [PF1] or [PF2] key (pp. 65-66).

Keypad Hotkeys

The keypad on the hand speaker microphone features hotkeys for faster access to the first nine menu options. When the radio is in MENU mode, press the desired hotkey to go directly to that option and press the UP / DOWN arrow keys to choose the desired setting. Press [MENU] to confirm, then press [EXIT] to save the setting and exit the menu.

Key	Hotkey	Function/Menu Item
1	SQL	Squelch menu function (page 5454)
2	PWR	Output Power menu function (page 54)

Key	Hotkey	Function/Menu Item
3	W/N	Bandwidth menu function (page 55)
4	RPT	Repeater menu function (page 55)
5	BRT-A	Active Backlight menu function (page 55)
6	BRT-S	Standby Backlight menu function (page 56)
7	W-ALT	Weather Alert menu function (page 56)
8	SAVE	Battery Saver menu function (page 57)
9	CTCSS	Receive CTCSS Tone menu function (page 57)
0		

Note

For instant access to any menu option while in the menu, simply enter the number of the menu option into the keypad. This is a faster and more convenient method of locating a specific menu option than by using the [UP] and [DOWN] keys or the Channel Knob.

Function Keys

The KG-XS20G has function keys to perform specific operations on the radio, from accessing and navigating the menu to the control of various modes. There are 8 keys on the front panel and 7 on the keypad of the hand microphone. The charts below list the keys at each location and what they do.

Front Panel Function Keys

Key	Function
BAND	Short Press: Switches primary and secondary areas (page 32) Long Press: Weather Mode (page 41)
MODE	Switches Channel and Frequency Modes (page 32)
TDR	Switches between single and dual display (page 31)
PF1	Programmable Function Key 1 (page 65)
MENU	Enter menu, select options and save to the radio
UP	Goes to the next channel, frequency or menu item

Key	Function
DOWN	Goes to the previous channel, frequency or menu item
EXIT	Exit the menu or cancel a function

Hand Microphone Function Keys

Key	Function
MAIN	Short Press: Switches primary and secondary areas (page 31) Long Press: Switches single and dual display (page 31)
MENU	Enter menu, select options and save to the radio
*SCAN	Short Press: Reverse Frequency (page 45) Long Press: Channel/Frequency Scan (page 38)
#LOCK	Press 2 seconds to lock/unlock keypad (page 40)
UP	Goes to the next channel, frequency or menu item
DOWN	Goes to the previous channel, frequency or menu item
EXIT	Exit the menu or cancel a function

Programmable Function Keys

The KG-XS20G has two programmable function keys [PF1] and [PF2]. The [PF1] key is located on the lower left side of the front panel between the hand microphone port and the display. The [PF2] key is located on the left side of the hand microphone below the PTT key. Each key can perform two different functions, one activated with a short press and one with a long press. These functions can be assigned to the [PF1] or [PF2] buttons from the menu (pp 65-66). They can also be assigned via the programming software.

Short Press	Long Press	Function	Description
X	X	UNDEF	Undefined - Key not assigned
X	X	BRT	Activate backlight (page 55)
X	X	DCS-SCAN	Scan for DCS code (page 61)
X	X	CTC-SCAN	Scan for CTCSS tone (page 61)
X	X	REVERSE	Activate reverse frequency (page 45)
X	X	TALK-A	Activate talkaround (page 44)

Short Press	Long Press	Function	Description
X	X	WEATHER	Activate Weather Mode (page 41)
X	X	MONI	Monitor channel (page 48)
X	X	FM-RADIO	Activate FM Radio (page 47)
X	X	SOS	Transmit SOS (page 45)
X	X	ALARM	Transmit alarm (page 46)
X	X	SCAN	Activate channel scan (page 38)
	X	SELE CALL	Selective Call (page 46)
	X	FRQ2-PTT	Secondary frequency PTT (page 47)

Menu Functions

[01: SQL] Squelch

Function: The squelch function mutes the speaker when no signal is detected. Adjusting the squelch sensitivity allows you to control how strong of a signal is required in order to unmute the speaker. Selecting a lower number will allow weaker signals to be heard, higher numbers require a stronger signal. Selecting [0] will unmute the speaker at all times. Squelch is set independently for each area.

Options: 0-9

Default: 5

[02: TX-POWER] Output Power

Function: Sets the transmit power of the radio. The radio has two power options: Low and High. Low power is 5 watts. Note, the transmit power for GMRS channels 1-7 are restricted by the FCC to 5 watts and can be used on Low power only. The transmit power of channels 15-22 and RPT15-22 can be used on High power. The KG-XS20G will automatically adjust the power to the FCC limits.

Options: HIGH/LOW

Default: (Varies by channel)

[03: W/N] Bandwidth

Function: Sets the bandwidth for the current channel.

Options: WIDE/NARROW

Default: (Varies by channel)

[04: REPEATER] Repeater

Function: Sets the offset frequency for a repeater channel. When this option is activated the KG-XS20G will transmit to the repeater input frequency when the radio is tuned to a frequency that has a valid GMRS repeater offset. This option is only available in frequency mode and will be ignored on frequencies that do not have a GMRS repeater offset. The offset is fixed to 5.000 MHz.

Options: OFF/ON

Default: OFF

[05: BRT-ACTV] Active Backlight

Menu Functions

Function: Sets the brightness of the LCD display backlight while the radio is transmitting, receiving, or otherwise active. There are 10 brightness levels from lowest (1) to highest (10).

Options: 1-10

Default: 8

[06: BRT-STBY] Standby Backlight

Function: Sets the brightness of the LCD display backlight while the radio is in standby. There are 10 brightness levels from lowest (1) to highest (10). The backlight can also be turned off.

Options: OFF/1-10

Default: 3

[07: WX-ALERT] Weather Alert

Function: Enables and disables the weather alert. Sets the alert for the currently active NOAA weather channel.

Options: ON/OFF

Default: OFF

[08: BAT-SAVE] Battery Saver

Function: Activate the battery saver feature. When active, the radio will scan less frequently for signals, improving battery life.

Options: ON/OFF

Default: ON

[09: RX-CTCSS] Receive CTCSS Tone

Function: Sets the receiving CTCSS tone for the selected channel. Use the arrow keys to select your preferred code and then MENU to confirm.

Options: OFF/50 CTCSS Tones

Default: OFF

[10: TX-CTCSS] Transmit CTCSS Tone

Function: Sets the transmitting CTCSS tone for the selected channel. Use the arrow keys to select your preferred code and then MENU to confirm.

Options: OFF/50 CTCSS Tones

Default: OFF

Menu Functions

[11: RX-DCS] Receive DCS Code

Function: Sets the receiving DCS code for the selected channel. Use the arrow keys to select your preferred code and then MENU to confirm.

Options: OFF/105 DCS+ Codes/105 DCS- Codes

Default: OFF

[12: TX-DCS] Transmit DCS Code

Function: Sets the transmitting DCS code for the selected channel. Use the arrow keys to select your preferred code and then MENU to confirm.

Options: OFF/105 DCS+ Codes/105 DCS- Codes

Default: OFF

[13: BACK-LT] Backlight Timeout

Function: Sets the amount of time that the display is active before switching to standby. The timer can be set from 1-20 seconds in one second increments. It can also be set to turn off immediately or always remain on.

Options: ALWAYS OFF/ALWAYS ON/1-20S

Default: 8 Seconds

[14: SCANMODE] Scan Mode

Function: Scan mode settings

Options: TO/CO/SE

Default: SE

TO: When a signal is detected, scanning stops. Scan will pause to wait for further activity and will then resume if no operation is carried out within 5 seconds. Pressing PTT will transmit on the currently selected channel.

CO: When a signal is detected, scanning stops and resumes immediately after the signal is lost. Pressing PTT will transmit on the currently selected channel.

SE: When a signal is detected, scanning stops. Pressing PTT will transmit on the channel where the signal was detected.

[15: SCANGP-A] Scan Group A

Function: Allows selection of a specific channel group in Area A for scan, or all groups. When a group number is selected, only channels in that group will be scanned when the Scan feature is activated.

Menu Functions

Options: ALL/1-10

Default: ALL

[16: SCANGP-B] Scan Group B

Function: Allows selection of a specific channel group in Area B for scan, or all groups.

When a group number is selected, only channels in that group will be scanned when the Scan feature is activated.

Options: ALL/1-10

Default: ALL

[17: PRI-SCAN] Priority Scan

Function: Activates scanning of the Priority Channel. During scan, the priority channel will be scanned more frequently. Read the “Channel Scan” section on page 37 to learn more.

Options: ON/OFF

Default: OFF

[18: PRI-CH] Priority Channel

Function: Selects the priority channel. This is used during scanning when the Priority Scan (menu option 18) feature is enabled. To select a priority channel, use the [UP] and [DOWN] keys to select a channel number.

Options: 999 channels

Default: CH: 01

[19: SCAN-ADD] Scan Add / Delete

Function: Add or remove a channel to/from the list of channels to scan.

Options: ON/OFF

Default: ON

[20: TONESCAN] CTCSS/DCS Scanning

Function: Scans the incoming signal for CTCSS or DCS tones to identify or confirm the correct tone. This function must be activated while receiving a signal.

Options: 1. CTCSS/2. DCS

Default: None. Choose the function and press [MENU] to activate the scan.

Note: The scan will stop when the signal ends and resume from where it left off the next time the signal is received, until it identifies the correct tone. Use the

Menu Functions

[UP]/[DOWN] arrow keys to scan in a different direction.

[21: TONESAVE] CTCSS/DCS Tone Save Options

Function: This item determines how a CTCSS or DCS tone is saved to a channel after a CTCSS/DCS scan.

Options: RX/TX/ALL

Default: RX

RX: Saves the scanned tone to the RX-CTCSS/DCS setting

TX: Saves the scanned tone to the TX-CTCSS/DCS setting.

ALL: Saves the scanned tone to both.

[22: STEP] Frequency Step

Function: Allows you to adjust the steps between frequencies. Available only in Frequency mode.

Options: 2.5K/5K/6.25K/10K/12.5K/25K/50K/100K

Default: 5K

[23: ROGER] Roger Beep

Function: Enables an audible roger beep prompt during transmission.

Options: OFF/BOT/EOT/BOTH

Default: OFF

BOT: Sets the roger beep prompt at the beginning of transmission

EOT: Sets the roger beep at the end of transmission

BOTH: Sets the roger beep at the beginning and end of transmission

[24: TOT] Transmit Overtime Timer

Function: When the transmission time exceeds the time set by the Transmit Overtime Timer, the unit will emit an error prompt and stop transmitting.

Options: 15-900 seconds (15 second increments)

Default: 60 seconds

[25: TOA] Transmit Overtime Alarm

Function: The Transmit Overtime Alarm warns when the Transmit Overtime Timer (TOT) is about to be exceeded. The red TX indicator LED (top of the radio) flashes to indicate an alarm. The alarm can be set to a maximum time limit of 10 seconds and indicates the amount of time prior to the Transmit Overtime

Menu Functions

Timer expiring that the warning will begin.

Options: OFF/1S-10S

Default: 5S

[26: VOX] Voice Activated Transmit

Function: The VOX function allows you to transmit without pressing the PTT key. The VOX function will detect that you are speaking into the microphone and then automatically begin transmitting. VOX gain levels of 1-10 are provided to allow you to adjust the voice detection sensitivity.

Options: OFF/1-10 (level)

Default: OFF

[27: VOICE] Voice Guide

Function: Enable or disable voice prompts.

Options: OFF/ON

Default: ON

[28: BEEP] Button Beeps

Function: Enables an audio prompt to alert the operator of a key press, input or fault.

Selectable: ON/OFF

Default: ON

[29: BUSYLOCK] Busy Channel Lockout

Function: Enabling Busy Channel Lockout prevents the transceiver from transmitting on a selected channel while another station or group is transmitting on it.

Options: ON/OFF

Default: OFF

[30: PF1-SHRT] Side Key PF1 Short Press Assignment

Function: Assigns a function to the [PF1] side key. A function is assigned to a short button press.

Options: UNDEF/BRT/DCS-SCAN/CTC-SCAN/REVERSE/TALK-A/WEATHER/MONI/FM-RADIO/SOS/ALARM/SCAN

Default: SCAN

[31: PF1-LONG] Side Key PF1 Long Press Assignment

Menu Functions

Function: Assigns a function to the [PF1] side key. A function is assigned to a long button press.

Options: UNDEF/BRT/DCS-SCAN/CTC-SCAN/REVERSE/TALK-A/WEATHER/MONI/FM-RADIO/SOS/ALARM/SCAN/SELEC CALL/FRQ2-PTT

Default: MONI

[32: PF2-SHRT] Side Key PF2 Short Press Assignment

Function: Assigns a function to the [PF2] side key. A function is assigned to a short button press.

Options: UNDEF/BRT/DCS-SCAN/CTC-SCAN/REVERSE/TALK-A/WEATHER/MONI/FM-RADIO/SOS/ALARM/SCAN

Default: FM-RADIO

[33: PF2-LONG] Side Key PF2 Long Press Assignment

Function: Assigns a function to the [PF2] side key. A function is assigned to a long button press.

Options: UNDEF/BRT/DCS-SCAN/CTC-SCAN/REVERSE/TALK-A/WEATH-

ER/MONI/FM-RADIO/SOS/ALARM/SCAN/SELEC CALL/FRQ2-PTT

Default: FRQ2-PTT

[34: SMUTESET] Secondary Area Mute Setting

Function: The Secondary Mute function mutes the speaker on the secondary area when the primary area is used. This prevents conflicting audio sounds and noise from both sides simultaneously when the radio is in dual receive mode.

Options: OFF/TX/RX/TX+RX

Default: OFF

TX: Mutes the speaker on the Secondary area when transmitting on the Master area.

RX: Mutes the speaker on the Secondary area when receiving on the Master area.

TX+RX: Mutes the speaker on the Secondary area when transmitting or receiving on the Master area.

[35: A-MUTE] A Area Mute Setting

Function: The A Area Mute function mutes the speaker on area A.

Options: OFF/ON

Menu Functions

Default: OFF

[36: B-MUTE] B Area Mute Setting

Function: The B Area Mute function mutes the speaker on area B.

Options: OFF/ON

Default: OFF

[37: WORKMODE] Work Mode

Function: Changes the working mode of the radio. This is equivalent to pressing the [MODE] button on the keypad.

Options: CH-NAME/FREQ/CH-NUM/CH-FREQ

Default: CH-NAME

CH-NAME: Channel Mode. Displays the channel name (Example: GMRS-01)

FREQ: Frequency Mode. Allows directly tuning any frequency in the wide receive range of the KG-XS20G. The radio transmits on GMRS frequencies only.

CH-NUM: Channel Mode. Displays the channel number (Example: CH-001)

CH-FREQ: Channel Mode. Displays the channel frequency (Example: 462.56250)

[38: CH-NAME] Channel Name

Function: Allows you to edit the name for the currently active channel. To edit a channel name, press [MENU] and choose the CH-NAME option. The name of the current channel will be in edit mode and the first character will flash to indicate it is currently being edited. Press the [UP] key to select the desired character, then press the [DOWN] key to move to the next position. When you finish editing the name, press [MENU] to save. This option is only available in Channel Mode.

Options: 8 Characters

Default: None

[39: CH-ADD] Add Memory Channel

Function: Adds a channel to the memory channel list.

Options: None

Default: None

[40: CH-DEL] Delete Memory Channel

Menu Functions

Function: Deletes a channel from the memory channel list.

Options: None

Default: None

[41: COMPAND] Compander

Function: The compander minimizes noise. Useful when transmitting over long distances.

Options: ON/OFF

Default: OFF

[42: SP-MUTE] Speaker Mute

Function: Speaker Mute settings

Options: QT/QT+DTMF/QT*DTMF

Default: QT

QT: All signals on the same CTCSS tone/DCS code will activate the speaker

QT+DTMF: Only those signals which include both the same CTCSS/DCS and dual-tone multi-frequency (DTMF) signal as the radio will activate the speaker.

QT*DTMF: Only those signals which have either the same QT or DTMF codes as

the radio will activate the speaker.

[43: ANI-SW] ANI-SW

Function: When activated, the radio will transmit the 3-6 digit Caller ID specified in menu option 44.

Options: ON/OFF

Default: OFF

[44: ANI-EDIT] ANI-EDIT

Function: Sets the Caller ID. The caller ID is composed of numbers 0-9. The first digit cannot be 0. ID numbers must be at least 3 digits and a maximum of 6 digits.

Options: 0-9

Default: 101

[45: SIDETONE] Sidetone Setting

Function: Activates the Caller ID and keypad sidetone during transmission.

Options: OFF/DTMF/ANI/DTMF+ANI

Default: DTMF

Menu Functions

DTMF: Activates keypad sidetone

ANI: Activates Caller ID sidetone

DTMF+ANI: Activates both keypad and Caller ID sidetones

[46: ALERT] Tone Alert

Function: Activates the tone alert. Some relay systems used for single-tone pulse transmissions need a single-tone pulse signal to activate.

Options: 1750Hz/2100Hz/1000Hz/1450Hz

Default: 1750Hz

Special Reminder: When in transmit mode, you can send the single-tone pulse frequency you've selected by pressing the [PF2] key on the side of the radio.

[47: PTT-DLY] PTT-Delay

Function: Delays transmission of the Caller ID code for a specified time. This delay time can be set to one of 30 levels in 100ms increments.

Options: 100~3000ms

Default: 300ms

[48: PTT-ID] PTT-ID

Function: Choose whether to transmit the ID at the beginning or end of transmission.

Options: BOT/EOT/BOTH

Default: BOT

BOT: Beginning of transmission

EOT: End of transmission

BOTH: Beginning and end of transmission

[49: RING] Ring Time

Function: Specifies the length of time to prompt when DTMF signals have been decoded.

Selectable: OFF/1S-10S

Default: 3S

[50: CALLCODE] Call Code

Function: Sets Selective Group Call codes. Selective Call Codes 3 to 6 digits. Call Codes can be set up through the programming software.

Menu Functions

Selectable: 1-20 Groups

Default: None

[51: RPT-TONE] Repeater Tone

Function: The repeater tone is the signal received by the radio when the repeater is offline.

Options: OFF/ON

Default: OFF

[52: TIMER] Stopwatch Timer

Function: Activates the radio's stopwatch feature. If ON, activate the stopwatch by short pressing [#LOCK] in standby mode.

Options: ON/OFF

Default: OFF

[53: AUTOLOCK] Auto Lock

Function: Automatically locks the keypad after 15 seconds.

Options: OFF/ON

Default: OFF

Note: To unlock the radio, hold the [#LOCK] key for 2 seconds.

[54: SPK-SET] Speaker Setting

Function: Selects which speaker emits audio.

Options: SPK1/SPK2/SPK1+2

Default: SPK1

SPK1: Radio Speaker

SPK2: Hand Microphone Speaker

[55: RADIOMEM] FM Radio Memory

Function: Save up to 20 FM radio stations into memory.

Options: MEMORY/RECALL

Default: RECALL

Note: To access the FM Radio, Press [PF2] on the side of the hand microphone. To store an FM radio station, press [SCAN] to scan stations. Once the desired station is found, press [MENU], go to RADIO-MEM and press [MENU] to activate the radio storage function. Press the [UP] and [DOWN] keys

Menu Functions

to choose MEMORY. Use the channel knob or the [UP] and [DOWN] keys to select an open memory channel, then press [MENU] to confirm. To Recall a station, press [MENU] to activate the radio storage function. Press the [UP] and [DOWN] keys to choose RECALL. Use the channel knob or the [UP] and [DOWN] keys to select a memory channel to recall, then press [MENU] to confirm.

[56: RESET] Factory Reset

Function: Resets the transceiver to factory defaults.

Options: VFO/ALL



Default: VFO

VFO: Resets function settings to factory defaults but retains channel parameters.

ALL: Resets all of the function settings and channel parameters to factory defaults.

DTMF Encoding

The KG-XS20G features dual-tone multi-frequency (DTMF) encoding. The number keypad on the radio corresponds to DTMF codes as follows:

MENU			EXIT		A	B	C	D
1 SQL	2 PWR	3 W/N	*SCAN		1	2	3	*
4 RPT	5 BRT-A	6 BRT-S	0		4	5	6	0
7 W-ALT	8 SAVE	9 CTCSS	#LOCK		7	8	9	#

Usage:

While pressing the [PTT] key to transmit, press the key on the keypad that corresponds to the DTMF tone that you wish to send.

Setting Non-Standard CTCSS or DCS

How to Set Non-Standard CTCSS

The KG-XS20G supports non-standard CTCSS codes in the range of 65.0-255.0Hz with a minimum spacing of 0.1Hz.

After selecting the CTCSS menu setting (RX-CTC or TX-CTC), enter the desired CTCSS code via the keyboard and then press [MENU] to confirm.

For example, to set the receiving CTCSS tone to 100.5Hz:

In standby, press [MENU] + [2] + [5], the screen will display: RX-CTC, press MENU, and input [1] + [0] + [0] + [5], then press [MENU] to confirm, and [EXIT] to return to standby.

How to Set Non-Standard DCS

The KG-XS20G supports non-standard DCS codes ranging from 000-766, except any code with the digit 8 or 9. For example, 680.719 is not a legitimate non-standard DCS

code.

After setting a non-standard DCS code, press the [LOCK] key to set it as a Positive or Negative code, or press the [SCAN] key to select OFF.

After selecting the DCS menu setting (RX-DCS or TX-DCS), enter the desired DCS code from the keypad on the hand microphone, press [LOCK] to select the Positive or Negative code, and then press MENU to confirm.

Example 1: Set the receive DCS as D105N

In standby, press [MENU] + [2] + [6] and the screen will display: RX-DCS. Press [MENU] and input [1] + [0] + [5], then press [LOCK] to select the Positive code. The screen will display D105N. Press [MENU] to confirm, and then press [LOCK] to return to standby.

Example 2: Set the receive DCS as D105I

In standby, press [MENU] + [2] + [6] and the screen will display: RX-DCS. Press [MENU] and input [1] + [0] + [5], then press [LOCK] to select the Negative code. The

Advanced Operation

screen will display D105I. Press [MENU] to confirm, and then press [EXIT] to return to standby.

Before assuming your KG-XS20G is defective, please check the following list of possible problems and solutions. The RESET option provided in the menu can be used to restore factory standard settings and programming, and will often solve issues.

Problem	Solution
Receive indicator is on but no sound is heard.	<ul style="list-style-type: none"> ■ Check volume level. ■ Disable CTCSS/DCS or be sure setting matches incoming transmission. ■ Check squelch settings.
Keypad is unresponsive	<ul style="list-style-type: none"> ■ Check if keypad has been locked. ■ Check if other keys are currently pressed
Unwanted interference is being received	<ul style="list-style-type: none"> ■ Enable CTCSS or DCS tone to filter out unwanted transmissions. ■ Use a different channel
Voice pause every 3 seconds	Check if the Priority Scan is active.

Troubleshooting

Problem	Solution
Cannot activate Scan	Check if the scan group channel or Scan Add function is turned on.
Cannot power on	<ul style="list-style-type: none">■ Check that the radio is properly wired and grounded to the vehicle.■ Check that the vehicle ignition switch is on.
Transceiver automatically turns off	Check if your power source is below 11.5 volts.

Specifications

Entire Radio	
Frequency Range	RX: 400-470 MHz (UHF) RX: 136-174 MHz (VHF) TX: GMRS Frequencies
Memory Channels	999
Work Mode	F2D / F3E
Work Temperature	-20°C~40°C / -4°F~104°F
Antenna Impedance	50Ω
Voltage	13.8VDC
Weight	22.36oz / 634g
Size	2.16 × 4.72 × 4.7 (in) / 55 × 120 × 119.5 (mm)

Technical Information

Receiver	Wide Band	Narrow Band	Transmitter	Wide Band	Narrow Band
Adjacent Channel Selectivity	≤70dB	≤60dB	Inter-modulation	≤65dB	≤65dB
Modulation	16K F3E	11K F3E	Adjacent Channel Power	≥70dB	≥60dB
Spurious Response	≤60dB	≤60dB	Spurious	≥70dB	≥70dB
Audio Response	+1~3dB (0.3~3KHz)	+1~3dB (0.3~3KHz)	Audio Response	+1~3dB (0.3~3KHz)	+1~3dB (0.3~3KHz)
Audio Distortion	≤5%		Squelch Sensitivity	≥45dB	≥40dB
Audio Power	≤500mW		Audio Distortion	≤5%	
Sensitivity	UHF/VHF : 0.25μV (12dB SINAD)		Output Power	20W	

Standard CTCSS and DCS Tones

The following is a list of the standard CTCSS and DCS tones supported by the KG-XS20G. Many FRS or GMRS radios display a number instead of a specific tone. The number to the left of the tone matches what is used by most manufacturers.

CTCSS									
1	67.0	11	94.8	21	131.8	31	171.3	41	203.5
2	69.3	12	97.4	22	136.5	32	173.8	42	206.5
3	71.9	13	100.0	23	141.3	33	177.3	43	210.7
4	74.4	14	103.5	24	146.2	34	179.9	44	218.1
5	77.0	15	107.2	25	151.4	35	183.5	45	225.7
6	79.7	16	110.9	26	156.7	36	186.2	46	229.1
7	82.5	17	114.8	27	159.8	37	189.9	47	233.6
8	85.4	18	118.8	28	162.2	38	192.8	48	241.8
9	88.5	19	123.0	29	165.5	39	196.6	49	250.3
10	91.5	20	127.3	30	167.9	40	199.5	50	254.1

Technical Information

DCS codes ending in *N* are positive. Negative DCS codes end in *I*. The KG-XS20G includes 105 positive and 105 negative codes.

DCS													
1	D023N	16	D074N	31	D165N	46	D261N	61	D356N	76	D462N	91	D627N
2	D025N	17	D114N	32	D172N	47	D263N	62	D364N	77	D464N	92	D631N
3	D026N	18	D115N	33	D174N	48	D265N	63	D365N	78	D465N	93	D632N
4	D031N	19	D116N	34	D205N	49	D266N	64	D371N	79	D466N	94	D645N
5	D032N	20	D122N	35	D212N	50	D271N	65	D411N	80	D503N	95	D654N
6	D036N	21	D125N	36	D223N	51	D274N	66	D412N	81	D506N	96	D662N
7	D043N	22	D131N	37	D225N	52	D306N	67	D413N	82	D516N	97	D664N
8	D047N	23	D132N	38	D226N	53	D311N	68	D423N	83	D523N	98	D703N
9	D051N	24	D134N	39	D243N	54	D315N	69	D431N	84	D526N	99	D712N
10	D053N	25	D143N	40	D244N	55	D325N	70	D432N	85	D532N	100	D723N
11	D054N	26	D145N	41	D245N	56	D331N	71	D445N	86	D546N	101	D731N
12	D065N	27	D152N	42	D246N	57	D332N	72	D446N	87	D565N	102	D732N
13	D071N	28	D155N	43	D251N	58	D343N	73	D452N	88	D606N	103	D734N
14	D072N	29	D156N	44	D252N	59	D346N	74	D454N	89	D612N	104	D743N
15	D073N	30	D162N	45	D255N	60	D351N	75	D455N	90	D624N	105	D754N

Default GMRS Channels and Frequencies

Simplex Channels

Ch.	Name	Frequency	Power
001	GMRS-01	462.5625	5W
002	GMRS-02	462.5875	5W
003	GMRS-03	462.6125	5W
004	GMRS-04	462.6375	5W
005	GMRS-05	462.6625	5W
006	GMRS-06	462.6875	5W
007	GMRS-07	462.7125	5W
008	GMRS-08	467.5625	RX Only
009	GMRS-09	467.5875	RX Only
010	GMRS-10	467.6125	RX Only
011	GMRS-11	467.6375	RX Only

Ch.	Name	Frequency	Power
012	GMRS-12	467.6625	RX Only
013	GMRS-13	467.6875	RX Only
014	GMRS-14	467.7125	RX Only
015	GMRS-15	462.5500	20W
016	GMRS-16	462.5750	20W
017	GMRS-17	462.6000	20W
018	GMRS-18	462.6250	20W
019	GMRS-19	462.6500	20W
020	GMRS-20	462.6750	20W
021	GMRS-21	462.7000	20W
022	GMRS-22	462.7250	20W

Technical Information

Repeater Channels

Ch.	Name	Receive Frequency	Transmit Frequency	Max Power
023	RPT-15	462.5500	467.5500	20 Watts
024	RPT-16	462.5750	467.5750	20 Watts
025	RPT-17	462.6000	467.6000	20 Watts
026	RPT-18	462.6250	467.6250	20 Watts
027	RPT-19	462.6500	467.6500	20 Watts
028	RPT-20	462.6750	467.6750	20 Watts
029	RPT-21	462.7000	467.7000	20 Watts
030	RPT-22	462.7250	467.7250	20 Watts

NOAA Weather Channels

Ch.	Frequency	Ch.	Frequency
1	162.4000	5	162.5000
2	162.4250	6	162.5250
3	162.4500	7	162.5500
4	162.4750		

Optional Accessories

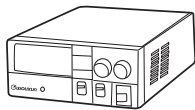

Switching Power
Supply (30A)

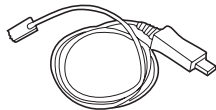

USB Programming
Cable



Mobile
Speaker / Mic

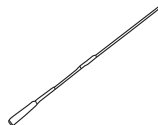

Omni-antenna

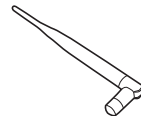

Omni-antenna



Directional-Antenna



Clamps Install
Mount

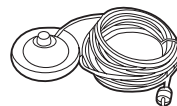

Strong Magnetic Mount

Shop Wouxun Accessories:

www.buytwowayradios.com/accessories/by-radio-brand/wouxun-radio-accessories.html

We warrant this product against defects in material and workmanship as follows:

Radio and its original primary components for a period of one (1) year from date of purchase.

Accessories (including battery, charger, belt clip, antenna and adapter) for a period of six (6) months from date of purchase.

This warranty is limited to the repair and replacement of the defective components and is not valid if the radio has been tampered with, misused, abused, used with unapproved accessories, subjected to unauthorized disassembly, unauthorized repair, replacement of unauthorized parts, unavoidable conditions, human destruction, water damage or environmental damage. This warranty is void if the serial number is defaced or altered.

If service, repair or replacement is required within the warranty period, such repair or replacement will be made free of charge by the dealer through whom the equipment was purchased. If the owner requires any service or repair from any dealer through whom the equipment was not purchased, the cost of repair must be made by the owner.

This warranty is valid for the original purchaser or owner of the product and is not

Limited Warranty

transferable.

THIS LIMITED WARRANTY IS THE ENTIRE WARRANTY FOR THIS PRODUCT AND IS IN LIEU OF ALL OTHER WARRANTIES, EITHER EXPRESSED OR IMPLIED, INCLUDING ANY WARRANTY OF MERCHANTABILITY AND FITNESS FOR A PARTICULAR PURPOSE. THIS WARRANTY DOES NOT COVER OR PROVIDE FOR THE REIMBURSEMENT OR PAYMENT OF ANY DAMAGES, INCLUDING INCIDENTAL OR CONSEQUENTIAL DAMAGES RELATED TO THE USE OF THIS PRODUCT. Some states do not allow this exclusion or limitation of damages so the above limitation or exclusion may not apply to you. This warranty is valid only within the United States of America.

Note: Product features, specifications and warranty terms are subject to revision by the manufacturer without notice. We are not responsible for unintentional errors or omissions on product packaging.