

MIDLAND®

MICRO**MOBILE**® GMRS 2-WAY RADIO



MXT275

midlandusa.com

Table of Contents

WELCOME TO THE WORLD OF MIDLAND.....	3
FEATURES.....	3
FCCNOTICE.....	4
Exposure to Radio Frequency Energy.....	4
INSTALLING YOUR RADIO.....	5
Preparation for Installation.....	5
Installing the Mounting Bracket.....	6
Installing the Antenna.....	7
Electrical and Rear Panel Connections.....	8
Connecting the Microphone.....	8
Using an External Speaker.....	9
CONTROLS AND INDICATORS.....	9
Microphone Operating Controls.....	9
Front Panel Connections.....	11
Back Panel Connections.....	11
LCD Display.....	12
OPERATING YOUR RADIO.....	13
About Range.....	13
Power On/Off.....	14
Selecting the Active Channel.....	14
Adjusting the Volume.....	14
To Transmit and Receive a Call.....	15
UTILITYFUNCTIONS.....	15
Locking the Keypad.....	15
Using Monitor Mode.....	16
Scanning for Active Channels.....	17
NOAA Weather Radio/Scan.....	17
To Manually Set the Weather Channel.....	18
To Enable Weather Alert.....	18
MENU MODE FUNCTIONS.....	19
Selecting a Privacy Code.....	19
Selecting the Transmit (TX) Power Level.....	21
Adjusting Squelch Sensitivity.....	21
Roger Beep.....	22
Call Alert Tone.....	23
Silent Operation.....	23
Repeater Channels.....	24
Selecting the LCD Display Background Color.....	24
CHOOSING YOUR OUTPUT SPEAKER.....	25
RESTORING THE DEFAULT SETTINGS.....	25
CARE AND MAINTENANCE.....	26
TROUBLESHOOTING GUIDE.....	26
SPECIFICATIONS.....	27
GMRS Frequency Chart.....	27
WX Weather Band Chart.....	27
GMRS Repeater Frequency Chart.....	27
CTCSS Privacy Codes Frequency Chart.....	28
DCS Privacy Codes Frequency Chart.....	28

ACCESSORIES.....	30
LIMITED WARRANTY.....	31

WELCOME TO THE WORLD OF MIDLAND RADIO

Congratulations on your purchase of a high quality MIDLAND product. Your MXT275 2-way radio represents state-of-the-art high tech engineering. Designed for General Mobile radio Service (GMRS) operation, this compact package is big on performance. It is a quality piece of electronic equipment, skillfully constructed with the finest components. The circuitry is all solid-state and mounted on a rugged printed circuit board. Your MXT275 radio is designed for reliable and trouble-free performance for years to come.

FEATURES

- 15 GMRS Channels
- 10 NOAA Weather Channels
- 8 Repeater Channels
- 142 Privacy Codes (38 CTCSS / 104 DCS)
- Monitor Function
- Keypad Lock
- Power Hi/Lo Settings
- External Speaker Jack

IMPORTANT!

Changes or modifications to this unit not expressly approved by MIDLAND RADIO CORPORATION could void your right to operate this unit. Your radio is set up to transmit a regulated signal on an assigned frequency. It is against the law to alter or adjust the settings inside the COMMUNICATOR to exceed those limitations. Any adjustment to your radio must be made by qualified technicians.

FCC NOTICE

The MXT275 operates on GMRS (General Mobile Radio Service) frequencies, which require a Federal Communications Commission (FCC) license. You must be licensed prior to operating on channels 1-7, 15-22 and repeater channels 15-22, which comprise the GMRS channels of the MXT275. Serious penalties may result from unlicensed use of GMRS channels, in violation of FCC rules, as stipulated in the Communications Act's Sections 501 and 502 (amended). You will be issued a call sign by the FCC that should be used for station identification when operating your radio on GMRS channels. You should also cooperate by engaging in permissible transmissions only, avoiding channel interference with other GMRS users, and being prudent with the length of your transmission time.

To obtain a license or ask questions about the license application, contact the FCC at 1-888-CALL FCC or go to the FCC's website:

[http:// www.fcc.gov](http://www.fcc.gov) and request form **605**.

This device complies with Part 15 of the FCC rules. Operation is subject to the condition that this device does not cause harmful interference

Exposure To Radio Frequency Energy

Your Midland radio is designed to comply with the following national and international standards and guidelines regarding exposure of human beings to radio frequency electromagnetic energy.

- United States Federal Communications Commission, Code of Federal Regulations: 47 CFR part 2 sub-part J
- American National Standards Institute (ANSI)/Institute of Electrical & Electronics Engineers (IEEE) C95. 1-1992
- Institute of Electrical and Electronics Engineers (IEEE) C95. 1-1999 Edition
- National Council on Radiation Protection and Measurements (NCRP) of the United States, Report 86, 1986
- International Commission on Non-Ionizing Radiation Protection (ICNIRP) 1998
- To control your exposure and ensure compliance with the general population or uncontrolled environment exposure limits, transmit no more than 50% of the time. The radio generates measurable RF energy exposure only when transmitting.
- The consumer must maintain a minimum safe separation distance of 33.54 inches (86 cm) from the antenna when transmitting.

INSTALLING YOUR RADIO

Preparation for Installation

This radio may be installed in any 12-volt, negative ground, system vehicle. Most current U.S. and Foreign vehicles use a negative ground system, but some older models and some newer large trucks may have a positive ground. Check the specifications for your vehicle before beginning installation. Generally, you have a negative-ground system if the negative (-) battery terminal is connected to the motor block. Contact your dealer if you are unable to determine your vehicle's polarity system.

1. Read these instructions completely before beginning installation
2. Read and follow all safety precautions in your vehicle's Service Manual.
3. Make sure all necessary tools, materials, and parts are on hand.
4. Disconnect the negative (-) battery cable before installing your radio. Be sure to reconnect the cable when installation is complete.
5. Determine a mounting location for your radio. The MXT275 is designed to be installed under the dash or vertically on the center console. Choose a location that does not impair visibility or interfere with driving. Also take into consideration the routing and length of the lead wires and cables to the power source, antenna, and/or optional external speaker.

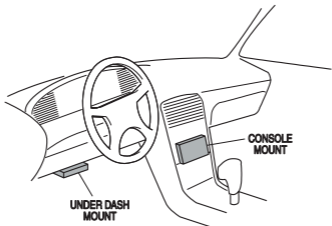

CAUTION: Extreme care should be exercised when drilling into the dash to avoid damage to under dash electronic ignition, cruise control, instrument and/or accessory wiring.

Installing the Mounting Bracket

1. Using the mounting bracket as a template, mark the location of each screw hole under the dash. Use a nail or other sharp pointed object to mark the hole locations.

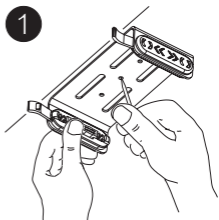

2. Attach the bracket to the dash with the Phillips head sheet metal screws provided. Tighten the screws securely. **DO NOT OVER-TIGHTEN.**

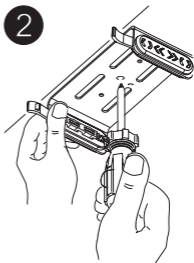

3. Slide the radio into the mounting bracket. **BE SURE** the mounting bracket retainers engage the slots in the sides of the radio to prevent movement while driving.

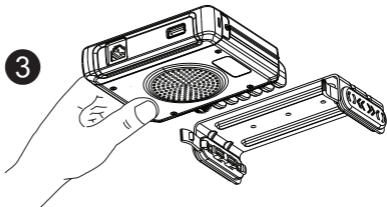

Installing the Antenna

The MXT275 includes a “magnetic mount” antenna, intended to be attached to the vehicle’s roof, trunk or similar location. Specific installation requirements vary between vehicles. Use the following guidelines to install the antenna.

Where you locate your antenna does make a difference.

Some general rules for antenna location that can aid radio performance.

1. Metal surfaces covered by fiberglass or vinyl may affect radio range. Avoid these locations.
2. Mount the antenna as high on the vehicle as possible. The higher the better.
3. If possible, mount the antenna in the center of whatever surface you choose.
4. The antenna cable is 19.7 feet (6 meters) long. Be sure the mounting location will allow for connection of the cable to the radio.
5. Be sure the mounting location is clean and dry before installing the antenna.
6. Route the antenna cable through an accessible entry point, such as a rear door or trunk opening.
7. When routing the antenna cable inside the vehicle, keep the cable away from noise sources, such as the ignition system, gauges, etc.
8. Exercise care to prevent cable damage. Make use of existing gaskets, grommets and weather stripping to protect the cable along its route.

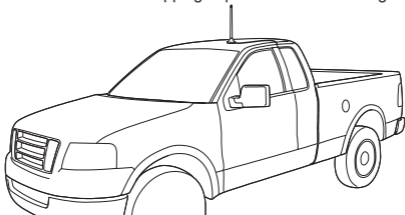

Electrical and Rear Panel Connections

Refer to **Rear Panel Connections** for rear panel connector locations.

NOTE: *Radio antenna is installed separately.*

1. The power cord supplied with the MXT275 is equipped with a cigarette lighter adapter for easy installation. Simply plug the connector into the vehicle's cigarette lighter. If a "hard-wired" installation is desired, connect the power cord to the vehicle's electrical system as follows:

- Cut the power cord just after the cigarette lighter adapter.
- Connect the positive lead (RED wire with in-line fuse holder) to either (a) the fuse block or (b) directly to the positive post of the vehicle's battery.

NOTE: *The fuse block is usually the most convenient connection point. The power cord positive lead can also be connected to the accessory terminal on the fuse block or ignition switch, so the radio automatically turns off when the ignition is turned off.*

- Securely connect the ground lead (BLACK wire) directly to the vehicle's metal frame. A good direct metal-to-metal ground is essential for optimum performance.

2. Attach the antenna cable to the **ANT** jack on the rear panel.

3. If desired, an optional external speaker (purchased separately) can be connected to the **EXT SPKR** jack (see **Using an External Speaker**).

Connecting the Microphone

Insert the RJ45 connector into the front of the MXT275. The microphone mounting bracket can be attached to the vehicle dash or other convenient location in a manner similar to the radio's mounting bracket..

Using an External Speaker

The MXT275 provides a rear-panel jack for connection of an optional external speaker (purchased separately).

When selecting an external speaker, ensure the speaker has 8-ohm impedance and is rated for 4.0 watts.

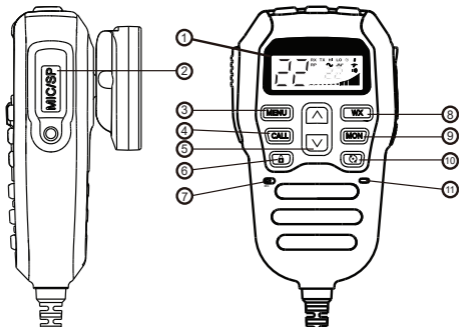

NOTE: When an external speaker is connected, the radio's internal speaker is automatically disabled.

CONTROLS AND INDICATORS



Microphone Operating Controls

1. LCD Display
2. Speaker/Microphone Jack
3. MENU - Press to access the menu
4. CALL - Press to send a call signal
5. Volume Buttons - Press to adjust the volume of the radio.

6.  Lock - Press and hold to lock the keypad
7. Mic - Built in Microphone
8. WX - Press and release the WX button to enter the Weather Radio Mode
9. MON - Press and release the MON button to activate the Monitor Function
10.  Scan - Press and release the Scan Button to activate the Channel Scan Function
11. Transmit/Receive Indicator - Light is red when you are transmitting a signal, the light is green when receiving a signal

Microphone Operating Controls (cont)

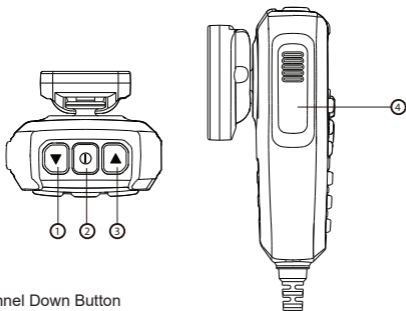

1. Channel Down Button
2. Power Button
3. Channel Up Button
4. Push to Talk Button

Front Panel Connections

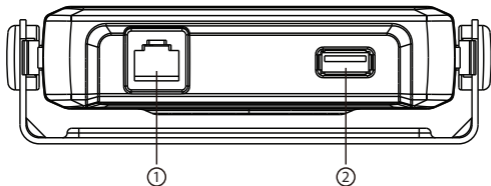





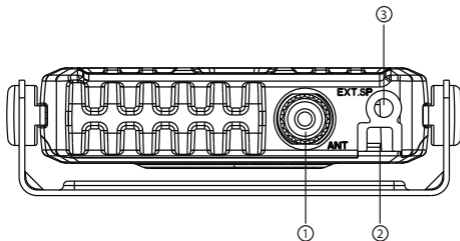



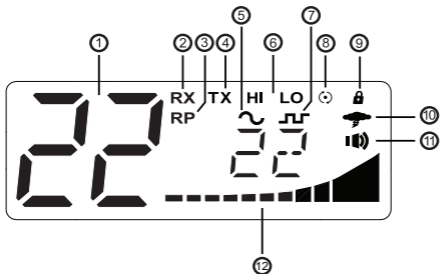

1. Microphone Jack
2. USB Charging Jack

Back Panel Connections



1. **ANT Jack** - SO-239 UHF connector for external antenna (included)
2. **EXT SPKR Jack** - 3.5mm audio connector for optional external speaker (purchased separately) (see **Using an External Speaker** for specifications).
3. **13.8V DC Cable** - 2-wire DC connector for 12V DC nominal input power connection



- 1. Channel Icon** - Shows the selected transmit/receive channel.
- 2.  Receiving Icon** - Indicates the radio is receiving a transmission from another user.
- 3.  Repeater Icon** - Shows the selected transmit/receive repeater channel
- 4.  Transmitting Icon** - Indicates the radio is transmitting to another user.
- 5.  CTCSS Icon** - Indicates a Continuous Tone Coded Squelch System
- 6.  Transmit Power Level Icon** - Indicates the Power Level Setting
- 7.  DCS Icon** - Indicates a Digitally Coded Squelch Privacy Code has been enabled for the currently selected channel
- 8.  Scanning Icon** - Indicates the "auto-scan" function is active.
- 9.  Key Lock Icon** - Indicates KEY LOCK mode is on
- 10.  NOAA Weather Band Icon** - Indicates when the radio is in the Weather Band mode
- 11.  Monitor Icon** - Indicates when the radio is in monitor mode
- 12. Signal Strength** - Indicates the strength of the current transmit or receive signal.

OPERATING YOUR RADIO

About Range

Your MXT275 is designed to give you maximum operating range under optimum conditions.



Optimum conditions for maximum operating range are:

- Over water
- In open rural areas without obstructions
- On flat areas where you can see the other radio user

To ensure you get maximum range:

- Be sure to mount the antenna (included) as high as possible on your vehicle
- Be sure to set your radio to use High power (see **Selecting the Transmit (TX) Power Level**)

Power On/Off

To turn the radio on and off:

1. With the radio off, press and hold the Power Button. You will hear a tone when the radio is on.
 - The LCD display will show all icons for one second and then display the most recently selected channel.
2. With the radio on, press and hold the Power Button.
 - The LCD display will go blank when the radio turns off.

Selecting the Active Channel

IMPORTANT! *To communicate between two radios, both radios must be set to the same channel and Privacy Code (see **Selecting a Privacy Code**) selections.*

To Select the Active channel:

1. Be sure the radio is turned on (See **Power On/Off**)
2. Press and release the **Channel Up** button on the microphone to scroll forward through the available channels. Press and release the **Channel Down** button on the microphone to scroll backward through the available channels.
 - The Channel icon on the LCD display will show the active channel.
 - To make the repeater channels selectable, see **Activate Repeater Channels**.

Adjusting the Volume

1. Press and release the **Volume Up** button to increase the volume
2. Press and release the **Volume Down** button to decrease the volume

Transmitting and Receiving a Call

IMPORTANT! To communicate between two radios, both radios must be set to the same channel and Privacy Code (see **Selecting a Privacy Code**) selections.

To transmit and receive a call:

1. Be sure the radio is turned on (see **Power On/Off**)
2. To transmit a call, press and hold the **PTT** button on the microphone, and speak into the microphone in a normal voice.

NOTE: For maximum clarity, hold the microphone 2 to 3 inches from your mouth when speaking.

- The **TX** icon will show continuously on the LCD display while transmitting.
3. To receive a call, release the **PTT** button on the microphone.
 - The **RX** icon will show on the LCD display when your radio is receiving a transmission.
 4. If necessary, press the Volume Up or Volume Down buttons to increase or decrease the radio volume.

UTILITY FUNCTIONS

Utility functions let you configure several operational parameters of the MXT275 to suit your personal preferences. For additional functions, see **"MENU" MODE FUNCTIONS**.

Locking the Keypad

You can use the keypad "lock" function to prevent accidentally changing your radio's settings. When the function is enabled, the current radio settings are "locked" in place.

NOTE: When the "lock" function is enabled, the **PTT** button, **Volume Buttons** and the **Call Button** on the microphone remain active.

To “lock” and “unlock” the keypad:

1. Be sure the radio is turned on (see **Power On/Off**)
2. Press and hold the **Lock** button for three seconds.
 - The **Keypad Lock** icon will show on the LCD display when the keypad is “locked.”
3. Repeat steps 1 and 2 to “unlock” the keypad.
 - The **Keypad Lock** icon will turn off when the keypad is “unlocked”.

Using Monitor Mode

Monitor mode lets you check for activity on the current active channel. You can also use Monitor mode to adjust the volume of your radio when not receiving a signal.

To enter and exit Monitor mode:

1. Be sure the radio is turned on (see **Power On/Off**)
2. Be sure you have selected the desired channel (see **Selecting the Active Channel**)
3. Press and release the **Monitor** button to enter **Monitor** mode. (the display will show the **Monitor** icon if the radio channel is busy)
 - You will hear any activity on the current selected channel.
4. Press and release the **Volume** Buttons to increase or decrease the volume
5. Once the volume has been adjusted to the desired level, press and release the **Monitor** button to exit **Monitor** mode.

Scanning for Active Channels

Your MXT275 includes an “auto-scan” mode that continuously scans all 15 available channels for activity.

To enter and exit “auto-scan” mode:

1. Be sure the radio is turned on (see **Power On/Off**)
2. Press and release the **Scan** button to enter “auto-scan” mode
 - The **Scanning** icon will show on the LCD display when the radio is in “auto-scan” mode.
 - Your radio will rapidly scan through the 15 available channels and will pause on any active channel.
 - “Auto-scan” will resume when there has been no activity on the current channel for four seconds.
3. To transmit during “auto scan,” press and hold the **PTT** button on the microphone while the radio is paused on the desired channel.
 - The radio will remain on the active channel for three seconds after the **PTT** button is released.
4. To exit the “auto-scan” mode, press and release the **Scan** button.
 - The **Scanning** icon will turn off when the radio is no longer in “auto-scan” mode.

NOAA Weather Radio/Scan

Your MXT275 has a NOAA Weather Radio function, to enable the user to receive weather reports from designated NOAA stations. Your radio also has a NOAA Weather Scan function, to enable the user to scan all 10 channels for the NOAA National Weather Service.

To enter and exit Weather Scan

1. Press and release the **Weather** button to enter weather mode.

2. The radio will then scan all 10 weather channels and will lock on to the strongest weather channel in your area.
3. Use the **Channel Up** or **Channel Down** on the microphone to force the radio to re-scan the weather channels while the radio is in scan mode
 - Pressing the **Scan** button takes the radio out of scanning mode, locking in the active channel. Press and release the **Scan** button to reactivate weather scan.
4. Press the **PTT** to exit Weather Mode.

To Manually Set the Weather Channel:

1. With the **Weather Scan** activated, press the **Scan** button to exit scanning mode
 - The Weather icon and active channel will stop flashing and will continuously be displayed on the LCD
2. Using the **Channel Up** or the **Channel Down** buttons on the microphone, manually set the active weather channel.

To Enable Weather Alert:

1. With Weather mode activated, press the **Scan** button to exit scanning mode
 - The weather icon and active channel will stop flashing and will continuously be displayed on the LCD
2. Use the **Channel Up** or **Channel Down** on the microphone to select the desired Weather Channel
3. Press and hold the **Weather** button to turn the Weather Alert on.
 - The weather icon will begin flashing
4. To return to GMRS mode, press and release the weather/PTT button.
 - When a Weather Alert goes off, the MXT275 will sound a siren. Pressing any button on the mobile will take you to the assigned weather channel and you will be able to hear the weather alert. If the siren stops prior to you entering the weather mode, the mobile will automatically take you to weather mode.

MENU MODE FUNCTIONS

The "Menu" mode provides access to the features and functions shown in the chart below. For additional utility functions, see **UTILITY FUNCTIONS**.

Quick Reference Chart

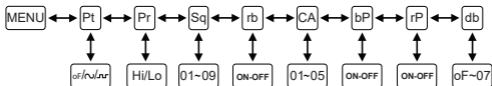

Pt - Privacy Tones - Use this option to set the privacy code.

Pr - Transmit Power Level - Use this option to change the transmit power level to Hi or Lo.

Sq - Squelch Sensitivity - Use this option to adjust squelch sensitivity.

rb - Roger Beep - Use this option to set the option for the Roger Beep.

CA - Call Alert Tone - Use this option to select the Call Alert tone.

bP - Silent Operation - Use this option to set the option for the keypad audible "beep" tones.

rP - Repeater Channels - Use this option to set the option for Repeater channels.

db - Display Background - Use this option to select the color of the display background.

Selecting a Privacy Code



Continuous Tone Coded Squelch System (CTCSS) and Digitally Coded Squelch (DCS) are systems that allow several users to share the same channel without disturbing each other. When CTCSS or DCS is enabled for a selected channel, the channel is muted to all incoming signals unless they carry the correct CTCSS or DCS tone.

When a transmission with the correct tone is received, the mute is removed and the voice audio can be heard. When the transmission ends the channel is muted again. Transmissions that do not have the correct tone are not heard.

The MXT275 has 142 Privacy Codes (38 CTCSS codes and 104 DCS codes), which can be applied to any channel. If desired, you can select a different Privacy Code for each channel. See **CTCSS Privacy Codes Frequency Chart and DCS Privacy Codes Chart** for lists of available Privacy Codes.

IMPORTANT! To communicate between two radios, both radios must be set to the same channel (see **Selecting the Active Channel**) and Privacy Code selections.

To select a Privacy Code:

1. Press and release the **Menu** button to place the radio in "Menu" mode.
2. Use the **Volume Up** or **Volume Down** button to scroll through the menu options until the LCD display shows **Pt**, then press the **Lock** button.
3. Use the **Volume Up** or **Volume Down** button to select the privacy tone type you would like to use: oF, Ct, or dC
4. Press the **Lock** button to confirm your selection.
 - The  (for CTCSS) or  (for DCS) icon will show on the LCD display, according to your selection
5. Use the **Volume Up** or **Volume Down** button to scroll forward or backward through the available Privacy Codes until the desired Privacy Code is shown on the LCD display.

NOTE: DCS Privacy Codes 100-104 are shown on the LCD display as A0-A4.

NOTE: Selecting a Privacy Code of "oF" will disable the Privacy feature.

- When the desired Privacy Code is shown on the LCD display, press the **Lock** Button to confirm your selection. YOU MUST PRESS THE **LOCK** BUTTON TO CONFIRM YOUR SELECTION OR THE PRIVACY CODE WILL NOT BE CHANGED

NOTE: *If you select a CTCSS Privacy Code, any pre-selected DCS Privacy Code will be cancelled, and vice-versa.*

Selecting the Transmit (TX) Power Level

The MXT275 provides two transmit power levels; **HI** and **Lo**. the **Lo** power level is generally suitable when operating under optimum conditions (see **About Range**). The **HI** power level is recommended to ensure you get maximum range from your radio.

To adjust the Transmit Power Level:

- Press and release the **Menu** button to place the radio in "Menu" mode.
- Use the **Volume Up** or **Volume Down** buttons to scroll the menu options until the LCD display shows **Pr**
- Press the **Lock** button to confirm your selection.
- Use the **Volume Up** or **Volume Down** button to toggle the transmit power setting between **HI** and **Lo**.
- When the desired transmit power level is shown on the LCD display, press the **Lock** button to confirm your selection. YOU MUST PRESS THE **LOCK** BUTTON TO CONFIRM YOUR SELECTION OR THE POWER LEVEL WILL NOT BE CHANGED.

Note: *Due to output power regulations channels 1 through 7 cannot be removed from the Lo transmit power setting.*

Adjusting Squelch Sensitivity

The MXT275 has adjustable squelch sensitivity. The minimum squelch level of 01 is the most sensitive, which allows the squelch to open on very weak signals. Setting the squelch to the maximum setting of 09 requires very strong signals to open the squelch.

To adjust the Squelch Sensitivity:

1. Press the **Menu** button to place the radio in "Menu" mode.
2. Use the **Volume Up** or **Volume Down** button to scroll through the menu options until the LCD display shows **Sq**.
3. Press the **Lock** button to confirm your selection
4. Use the **Volume Up** or **Volume Down** button to scroll forward or backward to select the desired squelch level, from **01** to **09**.
 - The default squelch setting is **04**, which generally provides reliable squelch operation for most applications.
5. When the desired squelch level is shown on the LCD display, press the **Lock** button to confirm your selection. **YOU MUST PRESS THE LOCK BUTTON TO CONFIRM YOUR SELECTION OR THE SQUELCH SENSITIVITY WILL NOT BE CHANGED.**

Roger Beep

When the PTT button on the mic is released, the radio will beep to confirm to other users that your transmission is complete

To Activate the Roger Beep:

1. Press and release the **Menu** button to place the radio in "Menu" mode.
2. Use the **Volume Up** or **Volume Down** button to scroll through the menu options until the LCD display shows **rb**.
3. Press the **Lock** button to confirm your selection.
4. Use the **Volume Up** or **Volume Down** button to select ON or OFF.
5. When the desired selection is shown in the LCD display press the **Lock** button to confirm your selection. **YOU MUST PRESS THE LOCK BUTTON TO CONFIRM YOUR SELECTION OR THE ROGER BEEP WILL NOT BE CHANGED.**

Call Alert Tone

Your MXT275 has 5 selectable Call Alert Tones

Selecting a Call Alert Tone:

1. Press and release the **Menu** button to place the radio in "Menu" mode.
2. Use the **Volume Up** or **Volume Down** button to scroll through the menu options until the LCD display shows **CA**.
3. Press the **Lock** button to confirm your selection.
4. Use the **Volume Up** or **Volume Down** button to scroll forward or backward through the tone options (01 - 05). When scrolling through the 5 options the sound will be played for you.
5. When the desired tone is found, press the **Lock** button to confirm your selection. YOU MUST PRESS THE **LOCK** BUTTON TO CONFIRM YOUR SELECTION OR THE CALL ALERT TONE WILL NOT BE CHANGED.

Silent Operation

The MXT275 has a Silent Operation mode. In this mode, all "beeps" and "tones" are disabled.

To Set the Silent Operation:

1. Press and release the Menu button to place the radio in "Menu" mode.
2. Use the **Volume Up** or **Volume Down** button to scroll through the menu options until the LCD display shows **bP**
3. Press the **Lock** button to confirm your selection
4. Use the **Volume Up** or **Volume Down** button to select ON or OFF.
5. When the desired selection is shown on the LCD display, press the **Lock** button to confirm your selection. YOU MUST PRESS THE **LOCK** BUTTON TO CONFIRM YOUR SELECTION OR THE SILENT OPERATION SELECTION WILL NOT BE CHANGED

Repeater Channels

Your MXT275 has the ability to access repeater channels. The use of a repeater can significantly increase a radio's range and coverage area. Prior to using a repeater you must coordinate with the owner of the repeater to gain permission to use the repeater. Be sure to understand and follow the sharing and usage rules for each repeater system.

To Set the Repeater Channel:

1. Press and release the **Menu** button to place the radio in "Menu" mode.
2. Use the **Volume Up** or **Volume Down** button to scroll through the menu options until the LCD display shows **rP**
3. Press the **Lock** button to confirm your selection.
4. Use the **Volume Up** or **Volume Down** button to select ON or OFF.
5. Press the **Lock** button to confirm your selection. YOU MUST PRESS THE **LOCK** BUTTON TO CONFIRM YOUR SELECTION OR THE REPEATER CHANNEL SELECTION WILL NOT BE CHANGED
 - When activated the repeater channels will be displayed as the channel number (Ex. 15,16,17,ect.) and the **rP** icon
 - Repeater channels will appear immediately following the standard GMRS channels (ex: 20,21,22,15_{rP},16_{rP},17_{rP} etc)

Selecting the LCD Display Background Color

Your MXT275 has 7 different color options for the LCD Display background.

To select the LCD Display background:

1. Press and release the **Menu** button to place the radio in "Menu" mode.
2. Use the **Volume Up** or **Volume Down** button to scroll through the menu options until the LCD display shows **db**
3. Press the **Lock** button to confirm your selection
4. Use the **Volume Up** or **Volume Down** button to select the LCD Display background color (oF - 07)

5. When the desired color has been selected, press the **Lock** button to confirm your selection. YOU MUST PRESS THE **LOCK** BUTTON TO CONFIRM YOUR SELECTION OR THE BACKGROUND COLOR WILL NOT BE CHANGED

Choosing your Output Speaker

You can choose which speaker you would like to use for your audio.

To Change the Primary Speaker used by your radio:

1. Press and release the **Lock** Button
2. Using the **Volume Up** and **Volume Down** Buttons, you will be able to scroll through the below options

Display Option	Description
HF AO	Handheld Speaker is Active. Radio Base Speaker is Off
HO AF	Radio Base Speaker is Active. Handheld Speaker is Off
HO AO	Both the Handheld and the Radio Base Speakers are active

3. Press and release the **Lock** Button to confirm your selection.

RESTORING THE DEFAULT SETTINGS

You can restore the original (factory default) settings for your MXT275 at any time.

To restore the default settings:

4. Be sure the radio is turned off (see **Power On/Off**).
5. Press and hold the **PTT** and the **Weather** button simultaneously..
6. With the buttons still held, turn on the radio.
 - All user settings will be cleared, returning the radio to all default settings.

CARE AND MAINTENANCE

CAUTION: DO NOT use alcohol or cleaning solutions to clean the radio. DO NOT immerse the radio in water.

1. Use a soft cloth moistened with water to clean the radio.
2. Dry the radio with a dry lint-free cloth should it get wet.

TROUBLESHOOTING GUIDE

If you experience difficulties using your MXT275, refer to the following chart to correct common operation problems. If you have a problem which you believe requires service, please call first and speak with a service technician at 816-241-8500. Many problems can be remedied over the phone without returning the unit for service.

PROBLEM	SOLUTION
No Power	Check vehicle power source (battery); replace as needed.
	Check input power connection and/or wires to vehicle power source.
Cannot Receive Messages	Verify both radios have the same channel selection and Privacy Code settings.
	Make sure you are within range of the other radio.
	Confirm communication is not affected by buildings and other structures (see About Range)
Keypad is not Responding	Make sure keypad "lock" is not on (see Locking the Keypad)
	Reset the radio (turn radio off then back on)
Display Backlight is Dim	Confirm your backlight setting is enabled

SPECIFICATIONS

Channels:	15 GMRS Channels and 10 NOAA Weather Channels
Privacy Codes:	38 CTCSS; 104 DCS
Operating Frequency:	UHF; 462.5500 ~ 462.725 MHz
Repeater Frequency:	UHF; 467.5500 ~ 467.725 MHz
Power Source:	13.8 VDC Nominal

GMRS Frequency Chart

Ch. No.	Ch. Freq. (MHz)	Ch. No.	Ch. Freq. (MHz)
1	462.5625	15	462.550
2	462.5875	16	462.575
3	462.6125	17	462.600
4	462.6375	18	462.625
5	462.6625	19	462.650
6	462.6875	20	462.675
7	462.7125	21	462.700
Ch 8 ~ 14 Reserved for FRS		22	462.725

WX Band Channels

Channel Number	Frequency (MHz)
1	162.550
2	162.400
3	162.475
4	162.425
5	162.450
6	162.500
7	162.525
8	161.650
9	161.775
10	163.275

GMRS Repeater Channels

Ch. Number	TX Freq. (MHz)	RX Freq. (MHz)
15RP	467.5500	462.5500
16RP	467.5750	462.5750
17RP	467.6000	462.6000
18RP	467.6250	462.6250
19RP	467.6500	462.6500
20RP	467.6750	462.6750
21RP	467.7000	462.7000
22RP	467.7250	462.7250

CTCSS Privacy Codes Frequency Chart

Code	Freq.	Code	Freq.	Code	Freq.	Code	Freq.	Code	Freq.
1	67.09	9	91.5	17	118.8	25	156.7	33	210.7
2	71.9	10	94.8	18	123.0	26	162.2	34	218.1
3	74.4	11	97.4	19	127.3	27	167.9	35	225.7
4	77.0	12	100.0	20	131.8	28	173.8	36	233.6
5	79.7	13	103.5	21	136.5	29	179.9	37	241.8
6	82.5	14	107.2	22	141.3	30	186.2	38	250.3
7	85.4	15	110.9	23	146.2	31	192.8		
8	88.5	16	114.8	24	151.4	32	203.5		

DCS Privacy Codes Chart

No.	Code	No.	Code	No.	Code	No.	Code
1	23	27	165	53	413	79	731
2	25	28	172	54	423	80	732
3	26	29	174	55	431	81	734
4	31	30	205	56	432	82	743
5	32	31	223	57	445	83	754
6	43	32	226	58	464	84	36
7	47	33	243	59	465	85	53
8	51	34	244	60	466	86	122
9	54	35	245	61	503	87	145
10	65	36	251	62	506	88	212
11	71	37	261	63	516	89	225
12	72	38	263	64	532	90	246
13	73	39	265	65	546	91	252
14	74	40	271	66	565	92	255
15	114	41	306	67	606	93	266
16	115	42	311	68	612	94	274
17	116	43	315	69	624	95	325
18	125	44	331	70	627	96	332
19	131	45	343	71	631	97	356
20	132	46	346	72	632	98	446
21	134	47	351	73	654	99	452
22	143	48	364	74	662	100	454
23	152	49	365	75	664	101	455
24	155	50	371	76	703	102	462
25	156	51	411	77	712	103	523
26	162	52	412	78	723	104	526

MIDLAND**X-TALKER***2-Way Radios**Weather Radios**Business 2-Way Radios***LXT / GXT***2-Way Radios**Emergency Crank Radios**CB Radios*

ACCESSORIES

Accessories can be purchased at midlandusa.com

LIMITED WARRANTY (United States and Canada)

Subject to the exclusions set forth below, Midland Radio Corporation will repair or replace, at its option without charge, any Midland FRS/GMRS which fails due to a defect in material or workmanship within One Year following the initial consumer purchase.

This warranty does not apply to water damage, battery leak, abuse or misuse of unauthorized accessories, unauthorized service or modification or altered products. Accessories have a 90 day warranty from date of purchase including the power cable, antenna, and microphone that are included with the unit.

ANY IMPLIED WARRANTIES, INCLUDING, WITHOUT LIMITATION THE IMPLIED WARRANTIES OF MERCHANTABILITY AND FITNESS FOR A PARTICULAR PURPOSE, SHALL BE LIMITED AS SET FORTH HEREIN AND TO THE DURATION OF THE LIMITED WARRANTY, OTHERWISE THE REPAIR OR REPLACEMENT AS PROVIDED UNDER THIS EXPRESS LIMITED WARRANTY IS THE EXCLUSIVE REMEDY OF THE CONSUMER AND IS PROVIDED IN LIEU OF ALL OTHER WARRANTIES, EXPRESS OR IMPLIED. IN NO EVENT SHALL MIDLAND BE LIABLE, WHETHER IN CONTRACT OR TORT (INCLUDING BUT NOT LIMITED TO NEGLIGENCE, GROSS NEGLIGENCE, BODILY INJURY, PROPERTY DAMAGE AND DEATH) FOR DAMAGES IN EXCESS OF THE PURCHASE PRICE OF THE PRODUCT OR ACCESSORY, OR FOR ANY INDIRECT, INCIDENTAL, SPECIAL OR CONSEQUENTIAL DAMAGES OF ANY KIND, OR LOSS OF REVENUE OR PROFITS, LOSS OF BUSINESS, LOSS OF INFORMATION OR DATA OR OTHER FINANCIAL LOSS ARISING OUT OF OR IN CONNECTION WITH THE ABILITY OR INABILITY TO USE THE PRODUCTS OR ACCESSORIES TO THE FULL EXTENT THESE DAMAGES MAY BE DISCLAIMED BY LAW.

For Product Purchased in the USA:

Performance of any obligation under this warranty may be obtained by returning the warranted product, prepaid freight, along with proof of purchase to:

**Midland Radio Corporation
Warranty Service Department
5900 Parretta Drive
Kansas City, MO 64120**

This warranty gives you specific legal rights, and you may also have other rights, which vary from state to state.

***NOTE:** The above warranty applies only to merchandise purchased in the United States of America or any of the territories or possessions thereof, or from a U.S. Military exchange.*

For Product Purchased in Canada:

Performance of any obligation under this warranty may be obtained by returning the warranted product, along with proof of purchase, to your place of purchase in Canada.

This warranty gives you specified legal rights. Additional warranty rights may be provided by law in some areas within Canada.

**THIS PAGE IS
INTENTIONALLY
LEFT BLANK**



MIDLAND RADIO CORPORATION

**5900 Parretta Drive
Kansas City, MO 64120
Call 816.241.8500**

**We'd love to hear from you! Let us know what
you think of your new Midland product at:**



or by visiting us at:

midlandusa.com

**Note: Features and Specifications are subject to change without
notice. MIDLAND RADIO CORPORATION is not responsible for
unintentional errors or omissions on its packaging.**