

16.2x11cm

Fujian Information Bureau(Radio Management Office)Remind:

The unit or individual who uses and the radio device must go to the related radio authority to apply for the formalities, after getting radio license can be allowed to use the radio. Set the radio station unauthorizedly、interfere radio service、work does not based on approved project and violate radio management rules, the radio regulatory agency will make an administrative punishment. The serious radio violations maybe violate the item 288 of Criminal Law or item 28 of Security Administration Punishment Act, who will be sentenced to imprisonment of not more than 3 years、joint or single fine、detained or controlled by Public Security Organs.

Warning 

- » Please turn off the transceiver in explosive environment (e.g. Coal gas、Dust、Steam etc.)
- » Please turn off the transceiver while refueling or parking at the gas station.

Precautions

Wouxun radios are high-quality with excellent design and advanced technology. The following suggestions will help user fulfil the obligation of warranty, and realize the security of using the transceiver.

1. Please put the transceiver and all accessories away from the children.
2. Please do not disassemble the transceiver as non-professional user maybe damage the transceiver.
3. Please use the company attached Battery pack and charger to avoid damaging the radio.
4. Please use the company attached antenna to avoid shortening communication distance.
5. Please do not put the transceiver near to the heating appliance or expose it in the sun for a long time.
6. Please do not put the transceiver in extremely dusty, moist, watery or unstable place.
7. Please do not wash the radio with strong chemicals or strong lotion.
8. Please do not transmit before installing the antenna.
9. Turn off the power supply immediately if the transceiver emits an unusual smell or smokes, then take out the battery or Battery pack and notify **Wouxun** dealer.

NOTE

- » All the above suggestions are used for **Wouxun** radios and accessories. Please contact with **Wouxun** dealer once the radios and accessories cannot be used.
- » Once the accessories are not produced by **Wouxun** company, the radio security and operation will not be warranted.

Contents



Professional FM Transceiver

Unpacking and Equipment Inspection	01
Preparation	02-07
Charging	02
Install Battery pack	03
Install Antenna	04
Install Belt clip	05
Install Audio Accessory	06
Mic/Speaker Case Installation	07
Device Information	08-13
Description of Features	08
Specifications	10
Parts Instruction	12
Basic Operation	14-16
Status Indication	17-20
LCD Icon	17
LED Indicator	20
Digital Function	
Phone book	21-22
View Contacts	21
Edit Contacts	21
Delete Contacts	21

Contents

Set Default Contacts	21
Shortcut Set	21
New Contacts	21
Manual Dial	22
Call Contacts	22
Call	22-23
Group Call	22
Private Call	22
All Call	23
Reply	23
Receive Call	23-24
Receive Group Call	23
Answer Private Call	24
Answer All Call	24
Call Records	24
Missed Call LCD Display	24
Call Records Storage	24
Call Records Delete	24
Message	25-28
Edit /Send Message	25
Edit /Send Preset Message	25

Check Message	26
Inbox	26
Outbox	27
Draft Box	28
Scan	28-31
Check Scan List	28
Edit Scan List	29
Scan Digit Hang Time	29
Scan Analog Hang Time	29
Priority Alert Tone	29
Priority Channel	29
Priority Sample Time	29
Scan Designated TX Channel	29
Response	30
Mark Channel	30
Private Line Type	30
Signal Hold Time	31
Start /Stop Time	31
Setting	31-38
Radio Setting	31
Radio Information	35

Contents

Radio Configuration	36
Side Key Definition	38
Emergency Alarm	38-39
Send Emergency Alarm	39
Receive Emergency Alarm	39
Reply Emergency Alarm	39
Remote Control	40-42
Call Alert	40
Radio Check	40
Remote Monitor	41
Radio Disable	41
Radio Enable	42
ARTS	42
VOX	42-43
Privacy	43
Record	43-44
Record on/off	43
Interval	44
Record Playback	44
Record Delete	44
FM Radio	45
Function Description	45-53

Contacts	45
RX Group List	46
Save Mode Receive	46
Save Preamble	46
Prompt Tone Disabled	47
CH Free Prompt Tone	47
Automatic Inspection Tone	47
Talk Permit Tone	47
Emergency Alarm Tone Time	47
Strange Number Tone	47
Reset Tone	48
TX Exit Tone	48
Receive Private Call Tone	48
Private Call Ring	48
Button Tone	48
Lone Worker Response Timer	48
Lone Worker Reminder Timer	48
TX Limit Fast Key	49
Disable Type	49
Channel Display	49
Dual Standby	49
TX Permissible Conditions	49

Contents

Color Code	50
TOT	50
TOT Rekey Delay	51
RX only	51
Talkaround	51
Group/Private Call Hang Time	51
Private Call Confirmed	51
Data Call Confirmed	51
DCDM Switch	52
TX Interrupt Frequency	52
Allow Interrupt	52
Repeater Time Slot	52
TX Wakeup Message Limit	52
Remote Monitor Time	53
TX Sync Wake up TOT	53
CTCSS/DCS Encode and Decode	53
DTMF System	53-56
DTMF Contacts	55
Manual Send Code	55
Simple Troubleshooting	57-58
Optional Accessories	59
Disclaimer	60

Unpacking and Equipment Inspection

Please take out the transceiver carefully, you' d better confirm if there are following accessories before you discard the packing material. If any item is lost or has been damaged during shipment, please notify  dealer immediately.

Accessory List

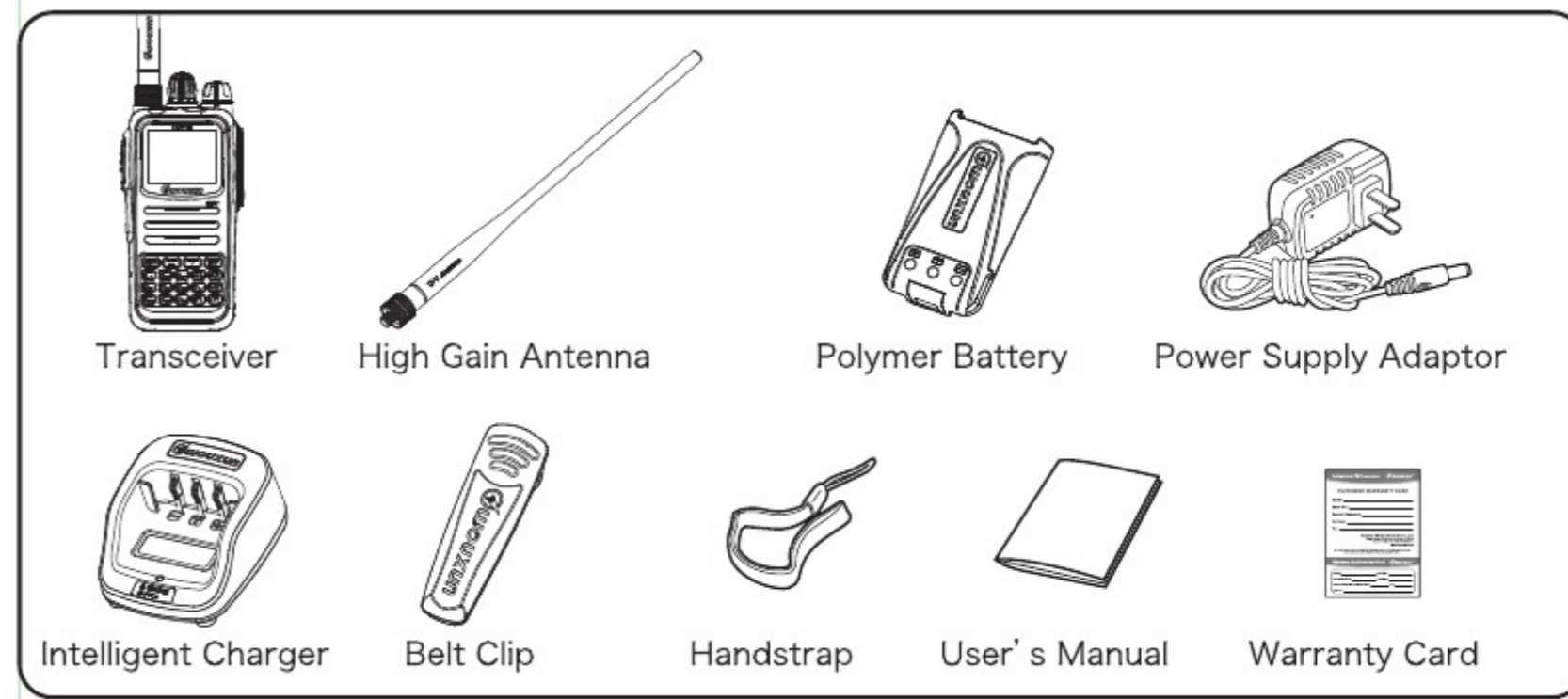

Preparation

■ Charging

The Battery pack maybe out of voltage during the long transportation, please re-charge the Battery pack with compatible charger before using it as following steps:

1. Insert power supply adaptor plug into jack of charger back.
2. Insert power supply adaptor plug into power socket.
3. Put Battery pack into charger.
4. According to the following charger LED light to know the current charging status.

LED Indicator Light	Current Charging Status
LED(red)flash slow	Trickle charging(this status lasts 10-20minutes after put exhausted Battery pack)
LED(red)always on	Charge
LED(green)always on	Full charge
LED(red)flash quick	Abnormal charging

NOTE

- » Please do not short connect the Battery pack port or put it into fire.
- » Please do not take off the case of Battery pack.

Preparation

■ Install Battery pack

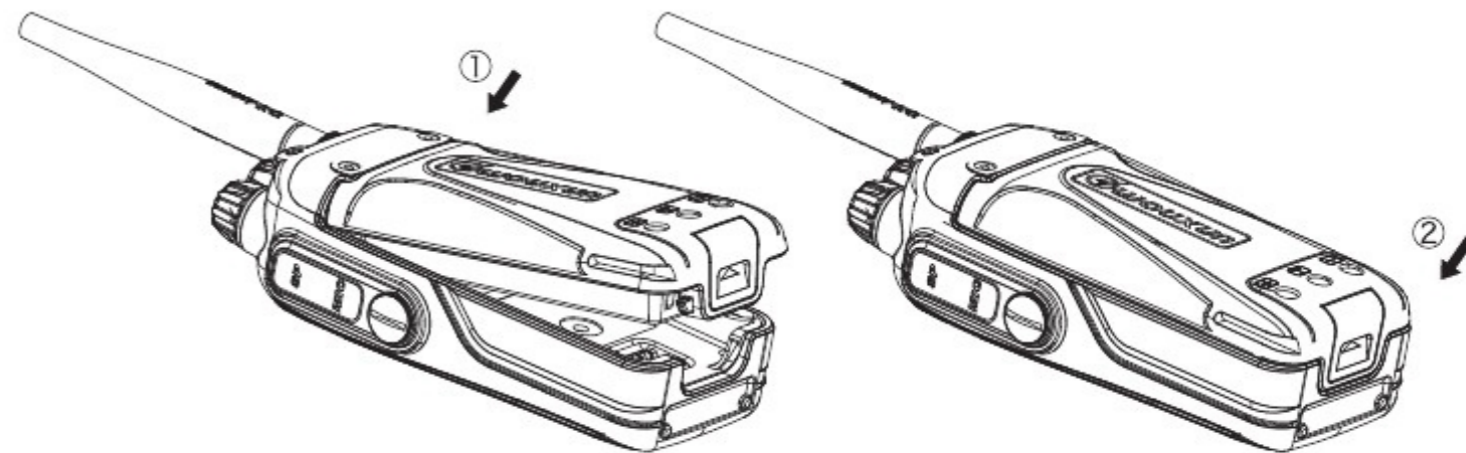

1. Aim the two card slot of Battery pack top at the card slot of the transceiver back, then press down the Battery pack until a clock tone, the bottom two release latch of the transceiver are locked.
2. Please turn off the transceiver before taking off the Battery pack, then lift the two release latch of transceiver back until Battery pack loose, take off the Battery pack.

Preparation

■ Install Antenna

Take the bottom of the antenna, aim at antenna port of transceiver top, rotate antenna clockwise until it's tight.



NOTE

- » Please do not hold the antenna top to swing it, or else which would reduce the antenna work performance and life.
- » Please do not rotate the antenna fiercely when install the antenna.

Preparation

■ Install Belt Clip

Aim the screw holes of belt clip at radio's screw holes and lock the belt clip with two screws.

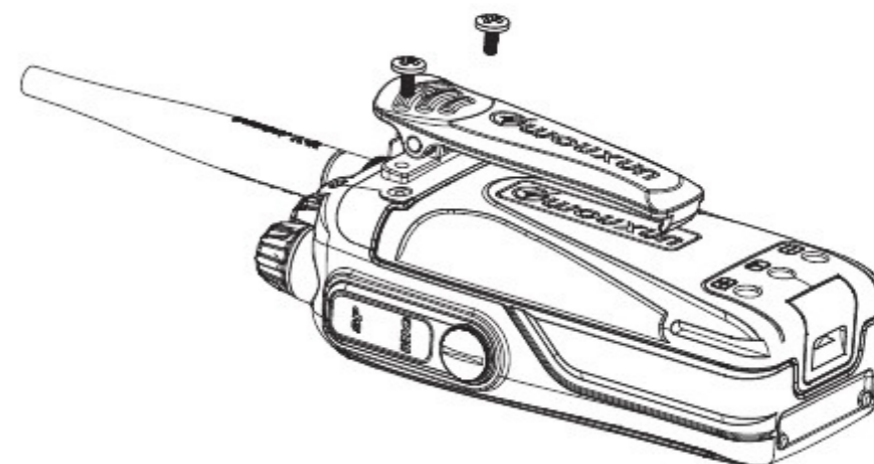

Preparation

■ Install Audio Accessory



Preparation

■ Mic/Speaker Case Installation



NOTE

» Please lock the accessory port when take off the accessory to avoid influence the terminal waterproof feature.

Device Information

Description of Features

1. Frequency band: 136-174& 400-480MHz FM(RX): 65.0-108.0MHz
2. 3072 channel
3. 256 contacts
4. 16 receiving group
5. 250 areas
6. 16 scan list
7. Radio ID
8. Radio TX contacts
9. Radio color code
10. Frequency range
11. Support Frequency Mode
12. Dual band dual display
13. Program key
14. Digit voice encryption
15. Emergency alarm
16. VOX function
17. Priority channel
18. Scan TX designated channel
19. Low battery power off
20. One touch relay/Talkaround
21. Radio program password
22. Menu encryption
23. Menu hide
24. Power save mode
25. Group scan
26. Tail elimination
27. High (UHF: 4W VHF: 5W) / LOW Power(1W)
28. Text Message
29. Lone Worker

Device Information

30. ARTS
31. Disable
32. Enable
33. Detection
34. Call Alert
35. Flashlight
36. CTCSS encoding/decoding (support non-standard)
37. Recording (support digital channel recording up to 8 hours)
38. Play recording file
39. Custom Radio Interface
40. DTMF encoding/decoding
41. Transmit time-out alert
42. FM Radio
43. Firmware Upgrade

Device Information

Specifications

Intergration	
Frequency Band	136-174&400-480MHz FM(RX): 65-108MHz
Channel Number	3072
Operating Temperature	-20°C ~ 40°C
Antenna Resistance	50Ω
Voltage	7.4V DC
Weight	300g
Size	130×64×40.5mm
Transmitter	
Output Power	UHF: H: 4W L: 1W VHF: H:5W L: 1W
FM Modulation	12.5KHz: 11K0F3E 25KHz: 16K0F3E
4FSK Digit Modulation	12.5KHz(data only): 7K60FXD 12.5KHz(data+voice): 7K60FXE
Adjacent Channel Power	≤-60dB
Frequency Stability	±1ppm
Audio Distortion	≤5%
Audio Response	+1~ -3dB

Device Information

Transmitter	
Vocoder Type	AMBE+2TM
Digital Protocol	ETSI-TS102 361-1, -2, -3
Bit Error Ratio	≤5%
Modulation Limit	±2.5KHz: @12.5KHz
Receiving	
Analog Receive Sensitivity	0.25uV@12dB SINAD
Digital Receive Sensitivity	0.25uV(BER: 5%)
Adjacent Channel Selectivity	≤60dB@12.5KHz
Audio Response	+1~ -3dB
Audio Distortion	≤5%
Audio Power	1W
Intermodulation	≥65dB

Device Information

Parts Instruction

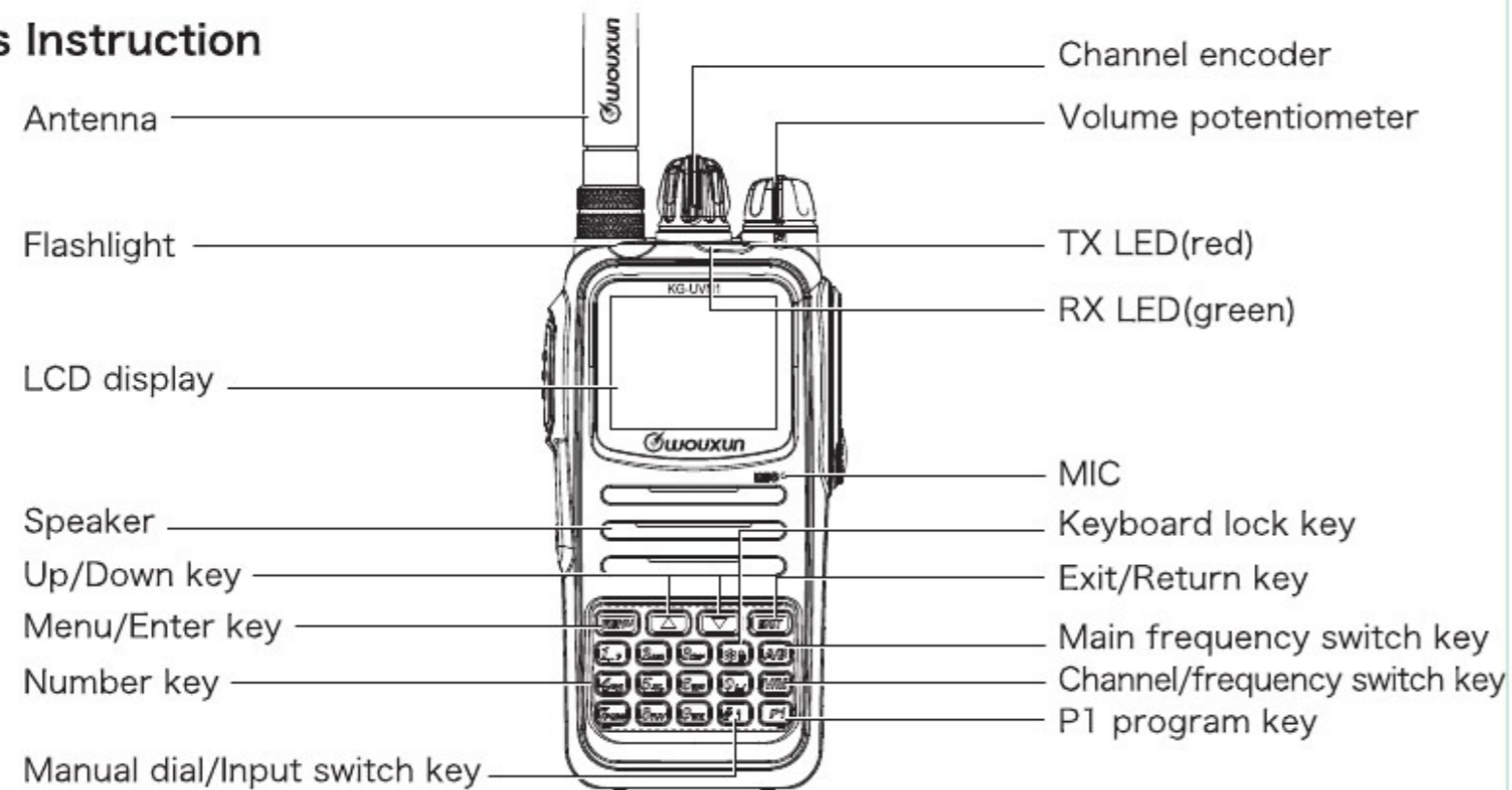

Note: In editing text message and name:

1. A/B key and V/M key can move the cursor up and down.
2. * key can clear the edited characters.
3. Up/down key can switch up/down row.

Device Information

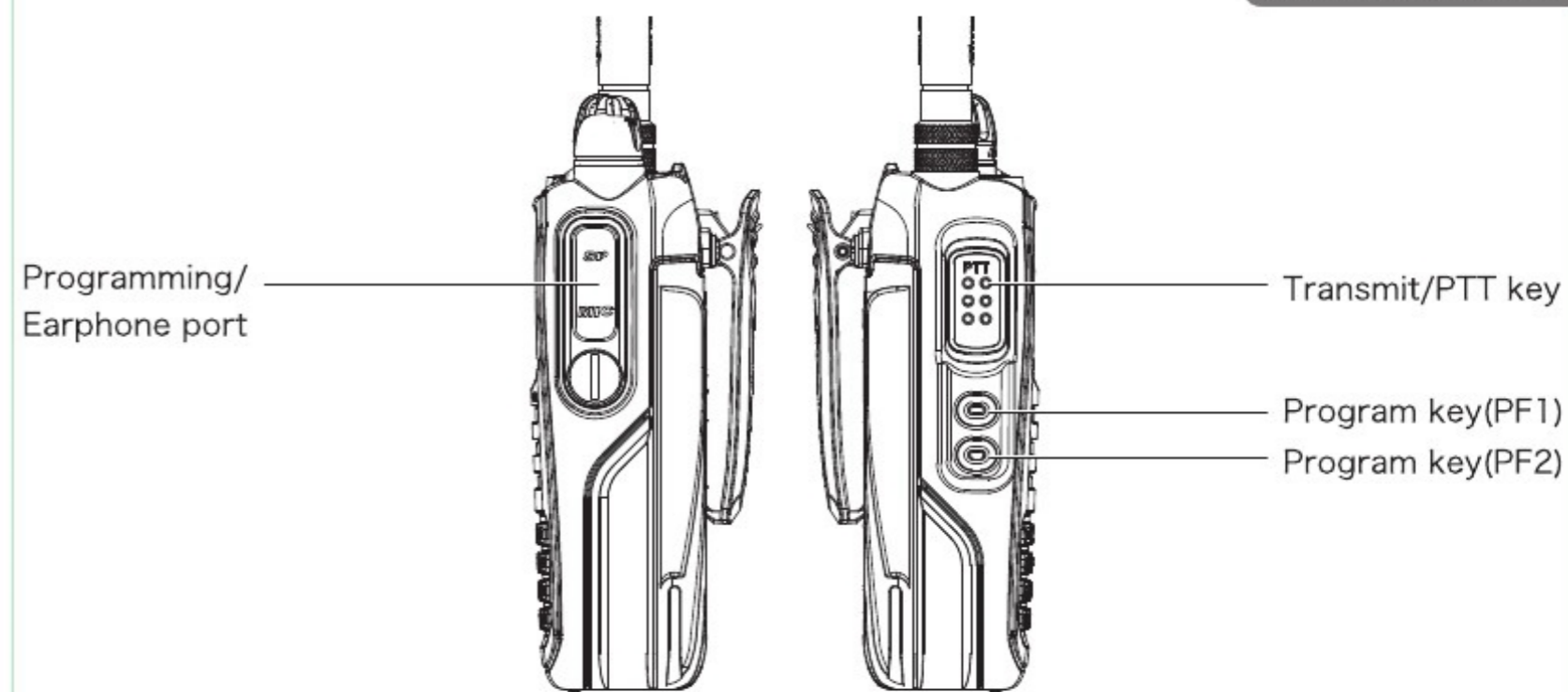

Note: Following function with program key:

All alert ON/OFF, Emergency mode ON/OFF, High/Low power select, Monitor, Temporary deletion of noise channels, One-touch 1-6, Repeat/Talkaround, Scan ON/OFF, Encrypt ON/OFF VOX ON/OFF, Switch area, Battery voltage indicator, Lone worker ON/OFF, Flashlight ON/OFF, Exit call.

Basic Operation

• Power on/off





Rotate the volume potentiometer clockwise until a clock tone, the radio power on. Rotate the volume potentiometer counter-clockwise until a clock tone, the radio power off.

• Volume Adjustment

Rotate the volume potentiometer clockwise to turn up volume, rotate the volume potentiometer counter-clockwise to turn down volume.

• Check Battery Voltage



When program key customized the battery voltage indicator, press the program key to check the current battery voltage through alert tone. When the battery voltage icon is , it shows low battery, please charge or replace the battery.

Battery Voltage Icon	Battery Voltage
	Full Battery
	Battery enough
	Battery reduce
	Battery lack
	Low Battery

Basic Operation

• Keyboard Unlock and Lock



When don't use keypad, user could lock it to avoid wrong operation.

1. Turn on the auto keyboard lock, if there is no any operation, voice and data to the radio, it will lock the keyboard automatically.
2. Manual keyboard lock: when turn off the keyboard lock, user can long press  to lock keyboard.
3. User could unlock the keyboard through [menu/enter key + ]

Note: When keyboard is locked, PTT key and program key still can be used.

• Keyboard Input

User can input contacts name and number, edit message, manual dial through digit keyboard of radio.

1. Switch input: 
2. Input punctuation: 
3. Input blank: 

• Switch Mode

User can switch the radio display mode manually.

Enter set→radio set→mode→serial number/name/frequency.

• Select Area

Area is a channel group, user can classify the channel with same property into a area to make a efficient management. The radio support 250 areas, each area can set at most 16 channel. User

Basic Operation

can select area as following methods:

1. Enter "area" menu, press **[up/down]** key to select demand area, then press **[menu/enter]** key to confirm.
2. Quickly enter "area" menu through program key, press **[up/down]** key to select demand area, then press **[menu/enter]** key to confirm.

• Select Channel

Channel is a passage for signal transmission. User can select channel as following two methods.

1. Rotate channel encoder to switch channel.
2. Through **[up/down]** key to switch channel.















• Set Backlight

The radio can set backlight time.

















Enter Set→Radio set→Back light→Backlight time.

Status Indication









LCD Icon

Icon	Product Status
Basic Status Icon	
	No signal
	More strip , stronger signal
	Digit Mode
	Analog Mode
	The current TX power is high power
	The current TX power is low power
	Analog CTCSS/DCS
	Digit CTCSS/DCS
	Digit mode, DCDM switch ON and work in time slot 1
	Digit mode, DCDM switch ON and work in time slot 2
	The current channel is wideband
	The current channel is narrowband
	Speaker ON, effective receiving
	Analog channel monitor
	Receive text message

Status Indication

	Positive slip frequency of Transceiver frequency
	Negative slip frequency of Transceiver frequency
	The current channel VOX ON
	Dual standby
	Keyboard lock
	Battery voltage indicate, more strip, more electricity
	The current main channel/frequency is Digit Mode
	The current main channel/frequency is Analog Mode
Menu Icon	
	Priority scan 1
	Priority scan 2
	Priority scan none
	Selected
	Not select
	Area
	Scan
	Text message

Status Indication

	Phone book
	Call records
	Setting
	Annex
Text Message Status Icon	
	Unread message
	Read message
Communication Status Icon	
	Call out
	Call in
	Hang on

Status Indication

LED Indicator

Indicator Status	Product Status
LED(green)always on	Receiving
LED(red)always on	Transmitting
LED(red)flash slow	Confirming private call/Trying connect repeater in relay mode
LED(red)flash quick	ARTS
LED(red)flash intermittent	Emergency alarm
LED(red+green)flash intermittent	Scan status/Digit channel receive call
LED(red+green)on simultaneous	Receiving digit voice encryption signal

Main Function

Phone Book

- **View Contacts**

Enter "contacts" menu, select the contacts, user can check contacts name and number.

- **Edit Contacts**

Enter "contacts" menu, select contact to edit, then select "edit name" or "edit number" to edit.
Note: This radio can only edit the name and number of private call contacts.

- **Delete Contacts**

Enter "contacts" menu, select a contact to delete.

- **Set Default Contacts**

Enter "contacts" menu, select a contact as the default contact to PTT transmit.

- **Shortcut Set**

Pre-set the shortcut key for contacts, then in digit mode, long press corresponding digit key to show contact , next press PTT key to transmit.

Enter "contact" menu, select contact to edit, then select "shortcut set" to set.

- **New Contacts**

Enter "contact" menu, select "new contacts" menu to enter, select the new contacts type, "group call" or "private call" , then input the number and name of new contact and confirm it.

Main Function

- **Manual Dial**

Enter “contact” menu, select “ manual dial” menu to enter, input contact number to call (private number), then press PTT to call.

- **Call Contacts**

Enter “contact” menu, select contacts (group call、 private call、 all call) , then press PTT key to make temporary call.

Call

- **Group Call**

Group call is a call of one to many.

Digit channel pre-set the group call contacts through programming software, then press PTT , the radio will make a group call in corresponding channel. When group call, LCD screen displays group call、 name、 ID and  .

- **Private Call**

Private call is a call of one to one.

Digit channel pre-set the private call contacts through programming software, then press PTT key, the radio will make a private call in corresponding channel. When private call , LCD screen displays private call、 name、 ID and  .



Main Function

- **All Call**

All call is a call to all contacts of current digit channel.

Digit channel pre-set the all call contacts through programming software, then press PTT key, the radio will make a all call in corresponding channel. When all call, LCD screen displays all call、 name、 ID and  .

- **Reply**

When receiving the group call or private call, after the call finished, during the group call hang time or private call hang time, LCD screen will display private call、 name、 ID and  or group call、 name、 ID and  , then the radio can reply the call directly through pressing PTT key.

Note: The group call and private call hang time can be programmed.

Receive Call

- **Receive Group Call**

The call of receiving group call need to set “ group call list” , add the corresponding contacts of group call type to “group call list” of digit channel. “Group call list” can be programmed. Each “group call list” allowed to add at most 15 contacts of group call type.

- **Receive Group Call**

After receiving group call, LCD screen displays group call、 name、 ID and  .

Main Function

- **Answer Private Call**

After receiving private call, LCD screen displays private call, name, ID and .

- **Answer All Call**

After receiving all call, LCD screen displays all call, name, ID and .

- **Call Records**

The radio can record all recently answered calls, missed calls and dialed calls of private call type. User can check and manage them through call records function.

- **Missed Call LCD Display**

When exist missed call, the radio LCD screen will display a missed call message, user can check it or later.

- **Call Records Storage**

User can check recently answered calls, missed calls and dialed calls of private call type through "call records" menu, then storage these contacts, the steps are the same as the operation of "news contacts".

- **Call Records Delete**

User can check recently answered calls, missed calls and dialed calls of private call type through "call records" menu, then delete these call records.

Main Function

Message

Text message includes text message and preset text.

1. Text message: the text information that can be checked, edited, sent, stored and deleted.
2. Preset text: the common text message that preset by dealer.

- **Edit/Send Message**

User can edit and send text message to contacts as following steps. After editing the text message, if you don't need to send it, storage it to draft box.

1. Select "write message" in "message" menu to edit text message.
2. Press **[menu/enter]** key to select "send", then select contact or input contact number through manual dial.
3. Press **[menu/enter]** key to send text message.

- **Edit/Send Preset Message**

Preset message: the common text message preset by dealer, the radio can be preset at most 50 message.

1. Preset text message can be programmed.
2. Send preset message: enter "preset message" menu, select a preset message, if you don't need to add or re-edit it, press **[menu/enter]** key to send, select contact or input contact number manually, press **[menu/enter]** key to send.

Main Function

• Check Message

1. Instant Check

Press **【menu/enter】** key to check the details when receive the message.

2. Check Message Through Menu

Select inbox、 outbox、 draft box or pre-set message in “message” menu, press **【menu/enter】** key to check details.

• Inbox

The inbox store the received message, which can store at most 16 messages.

1. Check Inbox message

Select “Inbox” menu in “message” menu, press **【menu/enter】** key to check details.

2. Reply Inbox Message

Select “Inbox” menu in “message” menu, press **【menu/enter】** key to enter, then press **【menu/enter】** key to reply, press **【menu/enter】** key to reply pre-set message or re-edit message.

3. Forward Inbox Message

Select “Inbox” menu in “Message” menu, press **【menu/enter】** key to enter, then press **【menu/enter】** key to forward, press **【menu/enter】** key to select contact or input contact number manually, press **【menu/enter】** key to send message.

4. Delete Inbox Message

Select “Inbox” menu in “Message” menu, press **【menu/enter】** key to enter, then press **【menu/enter】** key to delete.

Main Function

• Outbox

The outbox store sent message, which can store at most 16 sent message.

1. Check Outbox Message

Select “Outbox” menu in “Message” menu, press **【menu/enter】** key to check details.

2. Resend Outbox Message

Select “Outbox” menu in “Message” menu, press **【menu/enter】** key to enter, then press **【menu/enter】** key to resend.

3. Forward Outbox Message

Select “Outbox” menu in “Message” menu, press **【menu/enter】** key to enter, then press **【menu/enter】** key to forward, press **【menu/enter】** key to select contact, then press **【menu/enter】** key to send message.

4. Edit Outbox Message

Select “Outbox” menu in “Message” menu, press **【menu/enter】** key to enter, then press **【menu/enter】** key to edit.

5. Delete Outbox Message

Select “Outbox” menu in “Message” menu, press **【menu/enter】** key to enter, then press **【menu/enter】** key to delete.

• Draft Box

The draft box store unsent message, which can store at most 16 unsent message.

Main Function

1. Check Draft Box Message
Select "Draft Box" menu in "Message" menu, press **[menu/enter]** key to check details.
2. Send Draft Box Message
Select "Draft Box" menu in "Message" menu, press **[menu/enter]** key to enter, then press **[menu/enter]** key select "send" , press **[menu/enter]** key to select contact or input contact number manually, press **[menu/enter]** key to send message.
3. Edit Draft Box Message
Select "Draft Box" menu in "Message" menu, press **[menu/enter]** key to enter, then press **[menu/enter]** key select "edit" .
4. Delete Draft Box Message
Select "Draft Box" menu in "Message" menu, press **[menu/enter]** key to enter, then press **[menu/enter]** key select "delete" .

Scan

The radio supports group scan, please set scan list and assign it to single channel before using scan function, the radio support at most 16 scan lists, each scan list can be allowed 31 single channel. Scan list support analog、digit or digit/analog.

- **Check Scan List**

The radio can check scan list of current channel. Check list in "scan" menu, then press **[menu/enter]** key to check it.

Main Function

- **Edit Scan List**

User can add/delete channel of scan list, set priority channel of scan list, set priority channel sample time and set designated transmit channel.

- **Scan Digit Hang Time**

After scanning the digit channel, the time of staying in digit channel when digit channel signal disappear.

- **Scan Analog Hang Time**

After scanning the analog channel, the time of staying in analog channel when analog channel signal disappear.

- **Priority Alert Tone**

The alert tone when scanning the priority channel.

- **Priority Channel**

After setting the priority channel, scan each channel, the radio will re-scan the priority channel automatically.

- **Priority Sample Time**

It means the time of priority channel stay when scan. Priority sample time can be programmed. The time to scan priority channel of staying.

- **Scan Designated TX Channel**

Designate TX channel during scan. When scan, press PTT key, the radio will transmit with designated

Main Function

channel, which can be programmed.

1. Selected : transmit in current channel.
2. Transmit in any channel added from scan list.
3. Last active channel: transmit in voice active channel of last scan, if there is no signal to be scanned, transmit in current channel.

• Response

User can transmit through the scanned channel during scanning. If the function is forbidden, the radio will transmit on specified transmission channel.

• Mark Channel

When the scanned channel is non-priority channel which is set to receive CTCSS, after scanning priority channel in priority sample time, turn back to receive in the non-priority channel don't need to re-decode. The function of mark channel allow at most 20 times to don't need to re-decode.

• Private Line Type

Whether it need to match CTCSS during scanning.

Non-priority channel: In the channel that non-priority to scan list member need to match CTCSS.

Priority channel: In the channel that priority 1 or priority 2 to scan list member need to match CTCSS.

Priority and non-priority channel: the all channel to scan list member need to match CTCSS.

Forbidden: the all channel to scan list member don't need to match CTCSS.

Main Function

• Signal Hold Time

The time of the radio stay in the channel when a channel of analog scan list detects carrier signal. During the time the radio will decode the signal data of analog system. If the decoding information is incorrect, the radio will restore to scan.

• Start/Stop Scan

When start scan, the radio will monitor the channel that added from pre-programmed scan list repeatedly, the LED (red+green) will flash Simultaneously, LCD screen will display .

1. Manual Scan

Program key defined as "scan on/off" , user can turn on or turn off scan through corresponding program key.

2. Automatic Scan

When user select a activated automatic scan channel, the radio will start scan from activated automatic scan channel. When user switch to the inactivated automatic channel channel, scan function will turn off.

Setting

• Radio Setting

User can enter "radio setting" through the menu "setting→radio setting" to make some common operation as following instructions:

Main Function

Option	Description	Operation Method
Squelch	A threshold of the radio filters poor signal or background noise is higher than valid signal, if we choose "strict" squelch, the remote call signal will be filtered.	Select "Squelch" , then choose "normal" or "strict" . Note: through program key to switch current channel squelch function: normal/strict.
TX Power	The current transmit power level, user can set high/low power.	Select "TX Power" , then select high power or low power. Note: through program key to switch current channel power.
Talkaround	When repeater station goes wrong, or out of its coverage, the radio can switch to pass mode to communicate.	Select "Talkaround" mode on/off Note: To the transfer channel, turn on the Talkaround function need to edit through programming software. Also can through program key to switch current channel: talkaround/repeater function
Backlight	A light from the back of LCD screen and keyboard.	Select "backlight" , then select "backlight time" , user can select "always" or a fixed time.

Main Function

Busy Forbidden	The function is used for preventing the radio transmitting on the used channel.	Turn off: always allowing to transmit Carrier: when idle channel, allow to transmit. CTCSS/Color code: the same CTCSS/Color code, allow to transmit.
TOT	The time of radio can transmit constantly before the transmission stop automatically. The function can ensure channel cannot be occupied by any radio. To the busy channel, user can set a shorter TOT.	Select "TOT" , according to the needs to set TOT.
VOX	The function can set VOX to the selected channel. Which offers a convenient and non-manually sound-controlled communication.	Select "VOX" to enter and turn on/off it.
VOX Delay	The time of delayed transmission when MIC doesn't detect the voice.	Select "VOX Delay" and according to the needs to set delay time.

Main Function

Dual Standby	Set the radio's work mode.	Select "Dual Standby" and according to the need to set: Turn off: single display, single standby. Dual band dual standby: dual display dual standby. Dual band single standby: dual display single standby.
Privacy	Privacy function is about the digital encryption for channel voice, in order to protect the privacy and safety.	Select "Privacy", according to the needs to turn on it. Note: user need to preset the encryption group through programming software.
Power Save Switch	The radio electric circuit will turn off for a while and restart to detect the signal of current channel to reach the power saving, and which maybe lose the first part signal.	Select "Power Save Switch", then turn on/off it.
Backlight	A light from the back of LCD screen and keyboard.	Select "backlight", then select "backlight time", user can select "always" or a fixed time.
Keyboard Lock	A function of locking digit keyboard to avoid wrong operation.	Select "keyboard lock", then set a time to lock keyboard: manual or Automatic timing. Note: when set "keyboard lock" is manual, long press  key to lock it.

Main Function

LED Indicator	An indicator light when radio in a state or a designated action such as emergency alarm.	Select "LED indicator", then select "on/off".
Power on Password	When radio power-on, a right password to make radio enter normal working mode.	Select "Power on Password" and input current password(enter directly if there is not set password currently) to enter, then select turn on or change current password.
Mode	The radio channel working mode.	Select "mode", then select "Serial number/name/frequency".
Power on Interface	The interface picture or custom character that displayed by the radio display.	Select "Power on Interface", then choose "picture" or "preset character". Note: program the preset character need the programming software to preset.
Language	The language of menu on the radio LCD display.	Select "language", then according to the needs to choose "Chinese" or "English".

• Radio Information

User can enter the radio menu "set→radio information" to check radio name, radio ID and firmware, CP Software Version.

Main Function

• Radio configuration

User can enter the radio menu “set→radio configuration”, radio configuration offer some professional parameter setting function, if you don't understand the usage of these functions, please do not operate it.

If you don't need “radio configuration”, please turn off it through the menu to “radio configuration” of programming software. “Radio Configuration” description and operations as following.

Item	Description	Operations
RX Frequency	Settings for the current RX frequency.	Select the RX frequency, press MENU to confirm, press Exit key to delete the current frequency, and input the correct frequency, finally, press MENU to save into the channel.
TX Frequency	Settings for the current TX frequency.	Select the TX frequency, press MENU to confirm, press Exit key to delete the current frequency, and input the correct frequency, finally, press MENU to save into the channel.
Channel Name	Settings for the current channel name.	Select the Channel Name, press MENU to confirm, press Exit key to delete the current channel name, and input the new channel name, finally, press MENU to save. Note: Press # key to switch the input methods.

Main Function

Color Code	Color code is helping identification for the digital system. There are different color codes for different systems for the current digital channel. User can set the color code of the current digit channel.	Select the Color Code, press MENU to confirm, press UP/DOWN keys to select the required color code, finally, press MENU to save.
Repeater Slot	Repeater time slot is dividing the 12.5kHz channel into two for exchange by digital TDMA. Both of them are loading each calling in the repeater mode after successfully programmed into the current digital channel.	Select the RPT time slot, press MENU to confirm, press UP/DOWN buttons to select the required time slot, finally, press MENU to save into the channel.
Receive Group	User can set “receive group list” through programming software, add the IDs into the list of “RX Group”, and save the settings to the current channel.	Select “Receive Group”, press MENU to enter, press UP/DOWN key to select a receive group, then press MENU to save.
Channel Type	It means the radio work mode is digit or analog mode, when the radio in frequency mode, which can be set.	Select “Channel type”, press MENU to enter, press UP/DOWN keys to choose analog or digit mode, then press MENU to confirm.
Radio ID	The radio ID is independent, and it is used for calls by other radios.	Select the Radio ID, press MENU to confirm, press UP/DOWN buttons to select the ID number while press EXIT to delete the current numbers instead, finally, press MENU to save it.

Main Function

• Side Key Definition

User can enter "Side key" through the menu "Set→Side key", then select the function.

Note: the radio only offer some common shortcut function as following:

Alert tone ON/OFF, Emergency mode ON/OFF, High/Low power, Monitor, Repeat/Talkaround, Scan ON/OFF, Encrypt ON/OFF VOX ON/OFF, Switch area, Lone worker ON/OFF, Exit call, flashlight, FM radio.

When programming the except other functions, the radio will display No effect/Other.

Emergency Alarm

It send out the emergency signal whenever operations on the current channel or standby mode, and there are three alarm modes on this equipment. I.e., Current channel is 1, Emergency channel is 3.

1. Emergency Alarm: Alarm ON, and press PTT to transmit on the current channel, channel 1.
2. Emergency Alarm/Call: Alarm ON, and press PTT to transmit on the emergency channel, channel 3.
3. Emergency Alarm/Voice to Follow: Alarm ON, and press PTT to transmit on the current emergency channel. After alarm, microphone of this emergency channel is ON and ready for the automatic transmit. The transmitting time is controlled by the activated microphone.

Moreover, there are four alarm types for this function:

1. Disabled: Emergency call is forbidden on this equipment, but it is still available for RX emergency call from other radios.

Main Function

2. Regular: Radio sends out the emergency alarm, as well as the beep prompt and indicator.
3. Silent: Radio sends out the emergency alarm, but without the beep prompt and indicator, neither any RX calls from any other radios.
4. Silent w/ Voice: Radio sends out the emergency alarm, but without the beep prompt and indicator. However, regular RX calls from any other radios is available. It is programmable to select one of above options as the emergency button.

• Send Emergency Alarm

Emergency alarm is not the audio signal, which activates the prompt on another equipment, the TX contact of emergency channel is group call instead. After activation on the pre-programmed emergency button, the equipment sends prompt and the "Emergency Call"、Emergency Group Name and ID will display on the LCD.

• Receive Emergency Alarm

1. The receiving equipment will show the Sender ID on the LCD after receiving the emergency calls.
2. It prompts for receiving Emergency Calls.

Note: Press the pre-programmed emergency button, the equipment clears out all the receiving emergency prompts and exits from the emergency mode.

• Revert Emergency Alarm

When receiving the Emergency alarm, press PTT to start the revert call.

Main Function

Remote Control

The equipment achieves the call alert, radio check, radio monitor, radio disable and radio enable functions after receiving the command by remote control. There are two methods as following.

1. Go to Contacts menu, select the "Private Call" and press MENU to confirm. UP/DOWN Key to select any of the "call alert, radio check, radio monitor, radio disable and radio enable" functions, and finally press MENU to confirm.
2. Go to Contacts menu, select the "Manual Dial" , input the radio ID and press MENU to confirm. UP/DOWN Key to select any of the "call alert, radio check, radio monitor, radio disable and radio enable" functions, and finally press MENU to confirm.

Note: Remote Control is only workable to the contacts which belongs to private call.

• Call Alert

After the transmitter radio sends out "Call Alert" , LCD screen will display "Call Alert and Contacts Name or ID" , the receiving radio ring when receive " Call Alarm" . LCD screen will display "Contact Name or ID and Private Call Alert" , then Receiving radio can press PTT key to answer the call, press  to ignore the alert. If the call alert fail, then the LCD will display " Failed Call Alert" .

• Radio Check

The equip radio check command, there is radio check and contact name or ID display on the LCD, and the RX equipment will reply to the TX equipment if it is power on and available for communication.

Main Function

There is "Radio detect success" on the LCD, while "Radio detect fail" instead if failed checking.

• Remote Monitor

The equipment sends out the radio monitor command, there is radio monitor and contact name or ID display on the LCD. It display "radio monitor success" and start the radio monitoring if the target radio is monitored successfully. There is no any prompt for the monitored radio. It exits from the monitor screen after monitoring stops.

Note:

1. Target radio needs to activate the "Radio Monitor Decode" function under the Emergency System.
2. The monitoring time is programmable at "the remote monitor duration" option under the Emergency System.

• Radio Disable

The equipment sends out the radio disable command, there is radio disable and contact name or ID display on the LCD. It display "radio disable success" if the target radio is killed successfully. And LCD of the killed radio will display Activate or Reprogram.

Note:

1. Target radio needs to activate the "Radio Disable Decode" function under the Emergency System.
2. User can program the type of disabling the radio: disable, TX limit or TX/RX limit.

Main Function

• Radio Enable

The equipment sends out the radio enable command, there is radio enable and contact name or ID display on the LCD. It display “radio enable success” if the target radio is activated successfully. And there is resumed and ready for working mode after activation.

ARTS

ARTS is a system of “signal exchange”, the CTCSS encoding could ensure the two equipment which with the ARTS function are in a communication range. There will a alert when the equipment exceed the communication range.

ARTS turn on: enter the “general setting” of programming software to turn on the ARTS alert tone, set a CTCSS in analog channel and turn on ARTS. The radio will send/receive a communication distance every 20 seconds, the LED(red) will flash quickly and make a alert tone when there is no legal signal for 2 consecutive minutes.

VOX

VOX is workable for the hand-free voice call on the programmed channels.

Note:

1. Program the VOX function ON to the specified channels ahead.

Main Function

2. VOX Sensitivity: Manually select the VOX levels on menu list or software-general setting-VOX sensitivity.
3. User can turn on/off VOX of the current channel through pre-programmed program key.

Privacy

Privacy function is about the digital encryption for channel voice, in order to protect the privacy and safety. There are 16 groups for basic privacy.

Note:

1. Privacy function needs to be pre-programmed into the digital channel by software.
2. Keys for privacy is editable by 0-9 alpha numbers and A-F letters.
3. The privacy function can be turned on/off through “radio configuration” .

Record

Record function is about the recording for TX and RX voice on this radio, and supports maximum 8 hours for the recording memory. If over 8 hours, the new recording will automatically covers the oldest recording.

Note:

The recording only supports to both TX and RX voice on the digital channel.

• Record On/Off

Enter “ annex ” → “ record ” → “ mode ” to select turn on record mode.

Main Function

● Interval

The saving time of single recording file after setting continuous call, when there is no calls over interval time, it will be kept another recording file on the next call.

Note: the single recording file can be recorded at most 1 hour.

● Record Playback

Enter "Record" of annex, press UP or DOWN key to check, press MENU to enter, then press UP/DOWN key to select recording file to playback, finally press MENU.

Note:

1. You can view the information of the recording file like: Marks, Radio ID, Source ID, Call type, Record Time.
2. It supports view and play only on the current digital channels.

● Record Delete

Enter "Record" of annex, press UP or DOWN key to check, press MENU to enter, then press UP/DOWN key to select to delete all recording files.

Note:

1. It deletes all the recording on the current digital channels only.
2. User can only delete the all recordings but cannot delete the single recording.

Main Function

FM Radio

This equipment supports FM radio function, frequency is 65.0-108.0MHz.

Turn on FM radio function: Annex→FM Radio to enter and turn on. Press EXIT to exit the FM Radio.

Station Search: Press * key to start the automatic station searching for the FM.

Note: FM Radio has two automatic scan frequency, when the current frequency band is 65.0-76.0, the automatic scanning only in this frequency range, when the current frequency band is 76.0-108.0, the automatic scanning will in this frequency range only.

Manual Input: enter the radio, input frequency directly then press MENU to store.

Note: 1. The radio can store 20 FM station only.

2. In FM radio, when RX or pressing PTT to TX, the FM radio will temporary exit, then return to FM radio after TX and RX finished.

3. In emergency alarm, FM radio will not exit.

Storage Station: Enter FM Radio, press A/B key or V/M key to switch the stored station frequency.

Function Description

● Contacts

This is pre-programmed by the One Touch Access or PTT for TX contact. However, if the channel is added to many groups and one of them are working, then press the One Touch Access or PTT will transmit on the missed call last time instead of the new call on current channel.

Main Function

If you select None option on One Touch Access, then it stops to call on this channel.

- **RX Group List**

Add all the available contacts onto the group list(if the contact channel is selected the All CALL as call type, it will not be available list adding to the group list). Any operations on the contacts of the group list will be monitored by users, and the missed call will be call back if needed. This is also called group scanning.

If you select None option, then it stops user to receive any group calls except private calls.

- **Save Mode Receive**

It helps save the battery voltage when the radio is free standby. User presses any keys to return the working mode some time later, checking if there are any missed calls. If no calls, radio goes back to save mode. This helps the battery life, but it might delay the radio response.

Set the RX Low Battery Internals on the General Setting of software if the Save Mode Receive is ON.

- **Save Preamble**

Preamble is adding some characters before sending out the data(like text message, location information, registration, radio checking, private calls etc.). It extends the length of the messaging in order for the RX equipment to miss the former part. Also when the scanning members are added more and more, the preamble function can avoid the former parts of scanning missed. However, the preamble value is larger, the occupying time on the channels are longer. The time for preamble before TX is longer, so it helps the other radios not to miss the RX data during scanning but it

Main Function

makes the TX data less.

- **Prompt Tone Disabled**

Disable all prompt tone (button tone, call permit tone and CH free prompt tone), except the emergency alarm tone.

- **CH Free Prompt Tone**

When the voice communication is ended, there is indication tone. If the voice communication is stopped suddenly, there is also indication tone.

Note: Only the digital channels support this function.

- **Automatic Inspection Tone**

The radio will have a prompt tone after power on successfully.

- **Talk Permit Tone**

This tone is prompt whenever you use One Touch Access or PTT to start the TX, helping to remind the users that communication starts.

- **Emergency Alarm Tone Time**

After receiving the emergency alarm, the time that the emergency alarm tone lasts.

- **Strange Number Tone**

In digit mode receiving, the contact list of receiver without transmitter's number, there will be a prompt tone.

Main Function

- **Reset Tone**

When the hang time of digit channel talkaround group call/private call is up, there is a reset tone on exit.

- **TX Exit Tone**

Loosing PTT key after TX finished, there is a prompt tone.

- **Receive Private Call Tone**

When receiving the call of specific ID in digit channel, there will be a prompt tone.

- **Private Call Ring**

The ring type of prompt tone when digit channel receiving the specific ID .

- **Button Tone**

The prompt tone when operating the radio button.

- **Lone Worker Response Timer**

The timer is a part of lone worker function. It' s used for deciding the waiting time of sending prompt again after the last user activity.

- **Lone Worker Reminder Timer**

The timer is a part of lone worker function. It' s used for deciding the waiting time of sending emergency alarm again after the response timer finishing the timing.

Main Function

- **TX Limit Fast Key**

When analogue channel limited TX, user can press PTT key twice to transmit in one second.

- **Disable Type**

Set the disable type of digit or analog channel.

TX limit: forbid TX after disabling.

TX/RX limit: forbid TX/RX after disabling.

Disable: forbid TX/RX and cannot use the radio after disabling.

- **Channel Display**

Set the display of channel mode: Serial number/ Name/Frequency.

- **Dual Standby**

Set the radio working mode.

Turn off: the working mode is single display single standby.

Single standby: working mode is dual display single standby.

Dual standby: working mode is dual display dual standby.

- **TX Permissible Conditions**

Check and ensure that the programmed channel is permitting TX or sending message ahead, in order to avoid the radio is using the transmitting channel at the same time.

Main Function

Always: Press One Touch Access or PTT to directly transmit, it is called the impolite channel visit.

Channel Free: Radio checks if the channel is free for calling before transmitting, it is called the polite channel visit.

Compatible CTCSS/DCS: Radio checks if the CTCSS/DCS is compatible before transmitting. (Only used in Analog channels)

Compatible Color Code: Radio checks if the Color Code is compatible before transmitting. (Only used in Digital channels), it is called the polite digital system of channel visit.

- **Color Code**

It is programmable one color code to the specified channel, totally 15 codes. Some channels are using the same or different color codes. The repeater is using one color code only. Single color code is identifying one system, different color codes are identifying different systems, which helps the radios to use different systems. The radio scans all the channels with different color codes, and avoid the channel operations without the compatible color codes. The repeater which is using the same frequency is supportable to use different color codes. The administrator for the frequency spectrum hopes to use the different color codes to different users with the license, to share the channels as the part of agreement.

- **TOT**

TOT is the transmitting time stay for radios, in order to avoid that some channel is occupied for

Main Function

some communication for too long time. User will make the shorter TOT on some busy channels.

- **TOT Rekey Delay**

This function is the next transmitting time after the stop by TOT.

- **RX only**

The channels are programmed only RX available, could not TX.

- **Talkaround**

The equipment will switch to direct mode for communication if the repeater is out of working or out of the range.

- **Group Call/Private Call Hang Time**

User can set the hang time for receiving ID of the former group call or private call, and directly press PTT to call back.

- **Private Call Confirmed**

It confirms the private calls for the TX contacts on the digital channel. It starts transmitting if the private call is confirmed OK, while it prompts failed transmitting if not.

- **Data Call Confirmed**

It confirms the data call on the current digital channel, i.e. it needs to confirm back after the radios sends out the text message by private call.

Main Function

- **DCDM Switch**

It supports the data transmission for two channels on same frequency, and both of them are using the 12.5kHz bandwidth. The radios in the same group should be using the same time slot, so the time slot 1 will not interrupt the time slot 2. The radio needs to divide and track the structure of time slot to work normally. The radio as the regulator for the time slot is unique, and other radios should adjust the clock to make synchronization with the regulator.

- **TX Interrupt Frequency**

TX the interrupted signals before regular TX.

If interrupt successes, then it starts the voice communication. If interrupt failed, then it prompt failed.

- **Allow Interrupt**

It allows the TX interrupt from other radios during transmitting.

- **Repeater Time Slot**

It uses the TDMA technology to divide one 12.5kHz channel into two, and both of them separately carriers one call when working in the repeater mode.

- **TX Wakeup Message Limit**

It is the times settings for continuing transmitting the synchronization information on the digital channels.

Main Function

- **Remote Monitor Time**

Set the remote monitor time of digit channel to the target radio.

- **TX Sync Wakeup TOT**

It is the time settings waiting for the ACK to response to the sending information which is synchronization with the digital channel.

CTCSS/DCS Decode and Encode

It supports CTCSS/DCS decode and encode for analog channels to prevent interrupt, 50 groups of CTCSS and 105 groups of DCS selectable.

DTMF System

It supports to use the DTMF for modulation, and user should program the settings to analog channels ahead by software. And here are the settings as following each.

DTMF Side Tone: It sends the side tone of DTMF if sending the DTMF codes.

PTT ID: The ways of sending out the DTMF if press PTT or release PTT, four options: None, Pre Only, Post Only and Pre& Post.

Key Up Encode: Press PTT then send out the DTMF codes.

Key Down Encode: Release PTT then send out the DTMF codes.

Main Function

Personal ID: Set personal ID. Send the other ID directly to make private call.

Disable Code: Set the radio disabled code, the radio will be disabled when receiving the disable code.

Wakeup Code: Set the radio wakeup code, the disabled radio will restore the normal working mode when receiving the wakeup code.

Separator sign: when the radio need to display ANI code, the way of sending code is Counterpart ID + Separator sign + Radio ID.

Group Call Code: user can use DTMF character "A"、"B"、"C"、"D"、"*" or "#" to set a group call code "Universal Character". If the radio receive the effective ID, one or all codes among it are replaced by the universal character, the radio will decode. "universal character" is useful in group call, the station that called by group call cannot reply automatically.

Group Call Example:

Group Call Code C

The Personal ID of four radios are: A:123 B:223 C:235 D:355

If the Base Call use "C23", then A and B can receive the group call.

If the Base Call use "CC5", then C and D can receive the group call.

If the Base Call use "CCC", then all station can receive the group call.

Decoding Response: when receiving the matched ID code, the radio will response.

No: the radio don't response.

Remind: the radio make a prompt tone.

Reply: the radio wirelessly transmits and modulates the prompt tone.

Main Function

Remind and Reply: the radio makes a prompt tone and wirelessly transmits and modulates the prompt tone.

Disable/Activate Decoding: select turn on/off Disable and Activate function, when turning off, it's useless to decode.

Auto Reset Time: If there is no communication within the time after the DTMF decoding, the DTMF decoder will reset and mute the speaker.

First Digit: The delay time for sending the first digit of DTMF codes after PTT.

First Digit Time: The keep time for sending the first digit of DTMF codes after PTT.

Digit Time: The time for sending the DTMF codes which are included the   Digits.

DTMF rate: "DTMF rate" makes a fixed time interval among each digit to reduce the wrong decoding. User can select 5、6、10 digits each second.

• DTMF Contacts

The equipment supports 32 groups, each group is max supporting 16 codes. This is used for sending the DTMF codes of analog channels by One Touch Access.

• Manual Send Code

It supports to send the DTMF codes manually. If it is in the analog channel, press PTT to transmit, and input the codes through the keypad as follow. Or press # key to directly input the DTMF codes and then press PTT to transmit out.

Note: Please refer to the layout for the DTMF codes editing.

Main Function

				→	A	B	C	D	
						1	2	3	*
						4	5	6	0
						7	8	9	#

Simple Troubleshooting

Trouble	Reason	Solution
Radio could not be powered on.	Battery is not well installed.	Install the battery well again.
	Battery voltage is used up.	Re-charge the battery or change a new battery.
	Battery is dirty or broken then failed contact.	Clear the battery contact.
Call is failed.	Signal is poor.	Make sure the radio is working in the range.
Audio is not clear.	Signal is poor.	Make sure the contacts are working in the range.
Keys are not workable.	Keypad is locked.	Unlock the keypad.
	Keypad is stuck.	Resume the radio.
LCD is not working.	Display is stuck.	Resume the radio.
Rx audio is small, interrupted or mute.	Volume is low.	Make the higher volume.
	Antenna is loose or install incorrectly.	Power off and install the antenna correctly.
	Microphone is stuck or broken.	Clear up the microphone or change a new one.

Simple Troubleshooting

Radio could not contact with other members in the group.	Frequencies or settings are not compatible.	Make the settings compatible.
	Settings on the digital channels are wrong.	Make the settings compatible especially the digital channels.
	The communication range is too far.	Make sure that the all group are working in the range.
	Signal is poor.	Make sure that the all group are working in the range.
Big noise.	Interrupts from other users in the same frequency.	Change to other channels or adjust the squelch level.
	Signaling is not programmed well.	Program the compatible signaling for all the members in the same group.
	Signal is poor.	Make sure that the all group are working in the range.
	Location is poor for communication, like high building, basement.	Change to the wide surroundings.
	Interrupts by other electronics equipment.	Avoid the electronics equipment.

Please contact the local dealer or factory to get more warranty supports if above steps still not solved the problems.

Optional Accessories

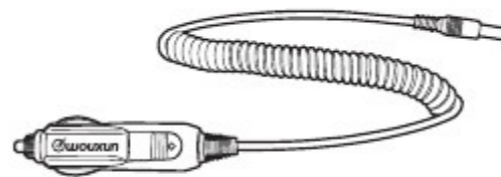

Car charger

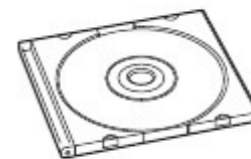

Programming CD



Headset



MIC/Speaker

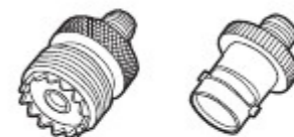

Antenna adapter

Disclaimer

We are working hardest to make the manual perfect, but there is still emission and printing errors, our company will not have any responsibility.

For the technical development, all the above specification is subject to updated by *Wouxun* without prior notice. Anyone cannot copy, modify, translate and distribute the manual without written authorization of *Wouxun*.

Ver: KG-UVN1-1810