

# Uniden®

## R3

# LONG RANGE Radar/Laser Detector

## User's Manual



## **CUSTOMER CARE**

At Uniden®, we care about you!

If you need assistance, please do NOT return this product to your place of purchase.

***Save your receipt/proof of purchase for warranty.***

Quickly find answers to your questions by:

1. Reading your owner's manual, included with this product.
2. Visiting our customer support website at [www.uniden.com](http://www.uniden.com).

***Images in this manual may differ slightly from your actual product.***

DISCLAIMER: Radar detectors are illegal in some states. Some states prohibit mounting any object on your windshield. Check applicable law in your state and any state in which you use the product to verify that using and mounting a radar detector is legal. Uniden radar detectors are not manufactured and/or sold with the intent to be used for illegal purposes. Drive safely and exercise caution while using this product. Do not change settings of the product while driving. Uniden expects consumer's use of these products to be in compliance with all local, state, and federal law. Uniden expressly disclaims any liability arising out of or related to your use of this product.

# CONTENTS

CUSTOMER CARE.....	2
<b>R3 OVERVIEW .....</b>	<b>5</b>
FEATURES.....	5
<b>INSTALL AND TURN ON R3 .....</b>	<b>6</b>
INSTALL/POWER ON.....	6
Windshield.....	6
Dashboard.....	6
<b>WHAT'S IN THE BOX .....</b>	<b>6</b>
<b>PARTS OF THE R3.....</b>	<b>7</b>
NON-KEY ELEMENTS .....	8
CHARGER .....	8
OLED DISPLAY.....	9
<b>MENU SYSTEM.....</b>	<b>9</b>
<b>BASIC OPERATIONS .....</b>	<b>12</b>
<b>FEATURE DETAILS .....</b>	<b>13</b>
USER MARKS (LASER AND RADAR SITES) .....	13
HIGHWAY VS CITY MODE .....	13
POP MODE.....	13
ALARM PRIORITIES.....	13
THREAT.....	14
MUTE MEMORY .....	14
AUTO MUTE .....	14
USER SPEED LIMIT.....	14
QUIET RIDE.....	15
<b>MAINTENANCE.....</b>	<b>15</b>
MAINTAINING THE EQUIPMENT .....	15
UPDATING THE FIRMWARE/DATABASE .....	15
<b>TROUBLESHOOTING.....</b>	<b>15</b>
<b>SPECIFICATIONS .....</b>	<b>15</b>
<b>FCC/IC COMPLIANCE .....</b>	<b>16</b>
<b>ONE-YEAR LIMITED WARRANTY .....</b>	<b>16</b>



# UNIDEN

## LONG RANGE RADAR/LASER DETECTOR

### USER'S MANUAL

## R3

### R3 OVERVIEW

Uniden's R3 is a top of the line Radar Detector with a built-in GPS feature. With the R3, you can mark geographical points where you commonly encounter radar transmissions. These can be school zones, red-light cameras, and places where police frequently monitor traffic. You can mark these points so the detector will announce "User mark ahead" when you approach them. Among other announcements, the Voice Notification feature lets you know when you are approaching a radar and what type of radar it is (red light, speed, etc).

### FEATURES

- Super Long Range Laser Radar Detection
- Voice Notifications
- Radar band frequency displays
- GPS for Red Light and Speed camera locations
- Easy to read OLED display
- User Mark set and voice notification
- Advanced K and Ka band filters
- Spectre I and IV undetectable
- Displays Signal Strength and Vehicle Battery Voltage
- Max. Speed Warning System

## INSTALL AND TURN ON R3

You can mount the R3 on the windshield (1- and 2- cup suction brackets included) or on the dashboard (hook and loop tape included).

### INSTALL/POWER ON

#### Windshield

When you mount the R3 on the windshield, mount it in the middle of the windshield between the driver and passenger. Be sure there are no obstructions and that there is a clear view through the windshield.

1. Attach the rubber suction cups to the bracket and push the cups firmly onto the windshield.
2. Slide the unit onto the bracket until it clicks into place.
3. Plug the power cord RJ11 connector into the R3 and plug the cigarette lighter adapter into the vehicle's cigarette lighter.
4. When the vehicle turns on, the R3 automatically turns on and runs through a self test cycle.

***Release the R3 from the bracket by pressing the Eject key on top of the detector.***

#### Dashboard

The same types of mounting requirements for the windshield apply for mounting the unit on the dashboard.

1. Attach the unit to the dashboard using the hook and loop fastener tape.

***Be careful not to cover any air vent holes with the hook and fastener tape.***

2. Plug the power cord RJ11 connector into the R3 and plug the cigarette lighter adapter into the vehicle's cigarette lighter.
3. When the vehicle turns on, the R3 automatically turns on and runs through a self test cycle.

***Pull the unit from the dashboard, separating the hook and loop tape.***

## WHAT'S IN THE BOX

	
<p>R3 Radar Detector</p>	<p>12V DC Power Cord with RJ11 Connector</p>
	<p>Not Shown: Hook and Loop Fastener Tape Owner's Manual</p>
<p>Windshield Mounting Bracket (1 Suction Cup)</p>	
	
<p>Windshield Mounting Bracket (2 Suction Cups)</p>	

# PARTS OF THE R3

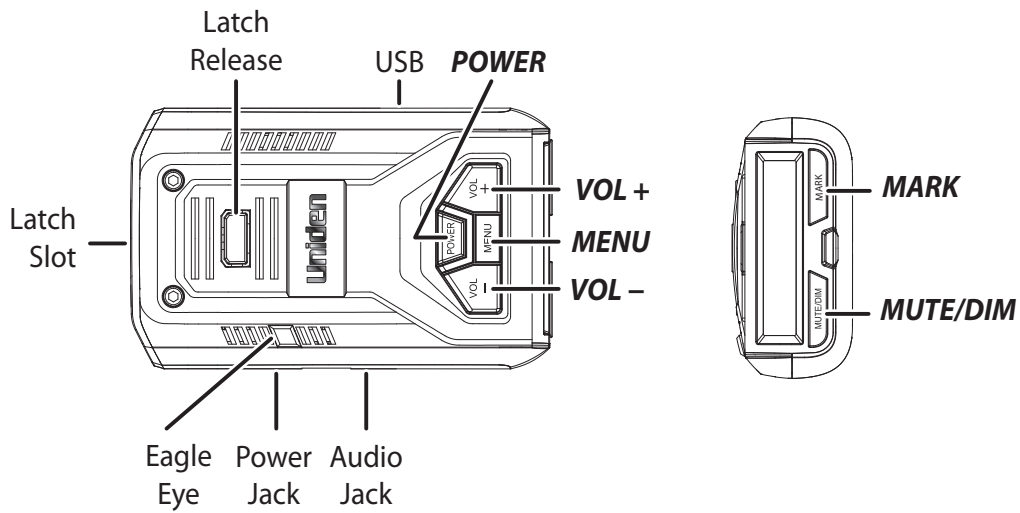

KEY	PRESS TO...	PRESS AND HOLD TO...
<b>POWER</b>	Turn R3 on and off.	NA
<b>VOL +</b>	<ul style="list-style-type: none"> <li>• Turn volume up (7 levels: 0 - 6).</li> <li>• In Menus, go to next item.</li> </ul>	NA
<b>VOL -</b>	<ul style="list-style-type: none"> <li>• Turn volume down (7 levels: 0 - 6).</li> <li>• In Menus, go to previous item.</li> </ul>	
<b>MENU</b>	<ul style="list-style-type: none"> <li>• Access the Menu system.</li> <li>• In Menus, press to cycle through options for the current menu item.</li> </ul>	When in Menu mode, exit the Menu system. When NOT in Menu mode, changes modes between Highway, City, and City 2.
<b>MUTE/DIM</b>	<p><b>MUTE</b></p> <ul style="list-style-type: none"> <li>• MUTE on - Press <b>MUTE/DIM</b> to mute an alarm. Returns to normal operation 10 seconds after the alert ends or if a different band is detected during Mute mode. <i>Mute On</i> displays for a few seconds.</li> <li>• MUTE off - Press <b>MUTE/DIM</b> to restore audible alarms before the 10 second automatic mute time-out.</li> </ul> <p><b>MUTE MEMORY</b></p> <ul style="list-style-type: none"> <li>• Save a Mute location (Mute Memory) - press <b>MUTE/DIM</b> again while <i>Mute On</i> displays to save that GPS location and frequency to memory. <i>Mute Memory</i> displays on the screen.</li> </ul> <p style="text-align: center;"><b>R3 stores up to 200 Mute Memory points.</b></p> <ul style="list-style-type: none"> <li>• Delete Mute Memory - Press <b>MUTE/DIM</b> while <i>Mute Memory</i> displays; the R3 displays a delete confirmation message. Press <b>MUTE/DIM</b> again to confirm.</li> </ul>	<p><b>DIM</b> - Changes the display and key backlight brightness:</p> <ul style="list-style-type: none"> <li>• Bright</li> <li>• Dim</li> <li>• Dimmer</li> <li>• Dark (Dark is off unless there is alert.)</li> <li>• Off (Off regardless of whether or not there is an alert.)</li> </ul>

KEY	PRESS TO...	PRESS AND HOLD TO...
<b>MARK</b>	<p>User Mark. A User Mark is a manually tagged geographic location where an alarm is usually found. The R3 alerts when close to these User Marks.</p> <ul style="list-style-type: none"> <li>• Add - Press <b>MARK</b> when you are at the alarm location.</li> <li>• Delete - Press <b>MARK</b> when you are at an alarm location that has been marked.</li> </ul> <p>An error message displays/sounds if memory is full or there is a GPS error.</p>	Delete all User Marks.

## NON-KEY ELEMENTS

ELEMENT	WHAT IT DOES
Eagle Eye	Provides a 360° monitoring radius.
Latch Slot	Insert the bracket latch into this slot.
Mini USB	Provides PC connection for data updates.
Audio Jack	Plug in headset.
Eject	Press to release the bracket latch.
Power Jack	Plug the 12V Power Cord here.
Signal Strength	Displays received signal strength (5 levels).

## CHARGER

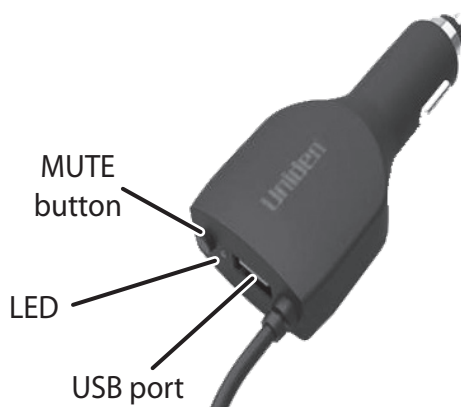

ELEMENT	WHAT IT DOES
MUTE button	<ul style="list-style-type: none"> <li>• Press the mute button to mute an alarm. Returns to normal operation 10 seconds after the alert ends or if a different band is detected during Mute mode. <i>Mute On</i> displays on the R3 for a few seconds.</li> <li>• Save a Mute location (Mute Memory) - press the mute button again while <i>Mute On</i> displays on the R3 to save that GPS location and frequency to memory. <i>Mute Memory</i> displays on the screen.</li> </ul> <p style="text-align: center;"><b>R3 stores up to 200 Mute Memory points.</b></p> <ul style="list-style-type: none"> <li>• Delete Mute Memory - Press the mute button while <i>Mute Memory</i> displays on the R3; the R3 displays a delete confirmation message. Press the mute button again to confirm.</li> </ul>
LED (Red)	<p>Off: Power is off.</p> <p>Steady on: Power is on.</p> <p>Flashing: Receiving an alert. The faster it flashes, the stronger the signal.</p>
USB Port	Use this USB port to charge mobile devices.









## OLED DISPLAY

The OLED display on the front of the unit changes depending on what events are happening.

*If GPS = ON, the OLED's left display area shows the display selected in the menus (see page 11).*

*If GPS = Off, the OLED's left display area shows Volt regardless of user settings.*

The following table provides examples of the most common displays:

OLED EXAMPLES	MEANING
<p>Scanning for Frequencies</p>  <p>Displays to indicate end of a scan cycle.</p>	<p>Information displayed in example:</p> <ul style="list-style-type: none"> <li>• Speed (mph or km/h)</li> <li>• Wave</li> <li>• Heart icon (end of search cycle)</li> <li>• Highway/City/City 2</li> </ul>
<p>Frequency Found</p> 	<p>Information displayed:</p> <ul style="list-style-type: none"> <li>• Band type Type (X, K, KA)</li> <li>• Frequency number</li> <li>• Voltage</li> <li>• Status Area (Mute Memory, Quiet Ride, etc)</li> </ul>
<p>Speed Camera Alarm</p> 	<p>Information displayed:</p> <ul style="list-style-type: none"> <li>• Current speed in mph/km/h</li> <li>• Distance to speed camera</li> <li>• Speed camera icon</li> </ul>
<p>Red Light Camera Alarm</p> 	<p>Information displayed:</p> <ul style="list-style-type: none"> <li>• Current speed in mph/km/h</li> <li>• Distance to red light camera</li> <li>• Red light camera icon</li> </ul>
<p>User Mark Detected</p> 	<p>Information Displayed:</p> <ul style="list-style-type: none"> <li>• Current speed in mph/km/h</li> <li>• Distance to user mark</li> <li>• User mark icon</li> </ul>
<p>Time Display (Scan Display Off)</p> 	<p>Information displayed</p> <ul style="list-style-type: none"> <li>• Voltage</li> <li>• Time and AM/PM</li> <li>• Highway/City/City2 setting</li> </ul>
<p>Quiet Ride</p> 	<p>Information displayed</p> <ul style="list-style-type: none"> <li>• Current speed in mph/km/h</li> <li>• Band type Type (X, K)</li> <li>• Frequency number</li> <li>• Status Area (Q-Ride displays)</li> </ul>

## MENU SYSTEM

Menus let you set up the system to your own requirements. You can turn different bands on and off and set specific items such as speed or auto mute.

Press **MENU** to access the Menu system. The screen displays the selection's current status. For example, if you press **MENU** and the screen displays *Voice: ON*, you have the option of turning Voice to OFF.

Use the following keys to navigate the menus:

- **MENU**: Change a menu item setting (press and hold to exit the Menu system).
- **VOL +** : Go to the next Menu item.
- **VOL -** : Go to the previous Menu item.

**Several menu items only display if GPS is set to ON. These entries are noted in the following table.**

MENU ITEM	WHAT IT DOES	SETTINGS
Highway	Changes band sensitivity as follows: <ul style="list-style-type: none"> <li>- Highway - Full Sensitivity</li> <li>- City - X and K sensitivity reduced. Ka band sensitivity same as Highway.</li> <li>- City 2 - X band detection off; K band sensitivity reduced. Ka band sensitivity same as Highway.</li> </ul>	Highway (Default) City City 2
GPS	Determines your geographic location. If GPS is turned on, other GPS-related menu items display.	On (Default) Off
Speed Camera (GPS on)	Notifies you if any speed cameras are nearby.	On (Default) Off
Redlight Cam (GPS on)	Notifies you if any red light cameras are nearby.	On (Default) Off
RLC Q-Ride (GPS on)	Red Light Camera Quiet Ride - Mutes red light camera alarms if you drive over the speed limit set here.	50 - 85 mph (80 - 140 km/h) Off (Default)
Voice	Turns voice alert on or off under the following conditions: <ul style="list-style-type: none"> <li>• Type of radar/laser</li> <li>• Band alarms</li> </ul>	On (Default) Off
X Band	Turn off to have the detector ignore X band frequencies. Turn on for X band sensitivity as follows: <ul style="list-style-type: none"> <li>• Highway: Full sensitivity</li> <li>• City: X band sensitivity reduced</li> <li>• City 2: X band off</li> </ul>	On Off (Default)
K Band	Turn off to have the detector ignore K band frequencies.	On (Default) Off
Ka Band	Turn off to have the detector ignore Ka band frequencies.	On (Default) Off
Laser	Turn off to have the detector ignore lasers.	On (Default) Off
K POP	Detects K POP transmissions (very brief transmissions, too fast for some detectors to hear).	On Off (Default)
Ka POP	Detects Ka POP transmissions (very brief transmissions, too fast for some detectors to hear).	On Off (Default)
K Filter	Filters noise from the K band to prevent false detections.	On Off (Default)

MENU ITEM	WHAT IT DOES	SETTINGS
Ka Filter	Filters noise from the Ka band to prevent false detections.	On Off (default)
TSF	Traffic Sensor Filter. Prevents false alarms caused by traffic monitoring radar systems.	On Off (Default)
K Narrow/Wide	K Narrow scans for K radar guns used in the US only and reduces false alarms.	K Narrow K Wide (Default)
Ka Narrow/Wide	Ka Narrow scans for Ka radar guns used in the US only and reduces false alarms. Ka Narrow also provides a fast response to Ka POP radar guns. Ka Wide scans Super Wide Ka band.	Ka Narrow (Default) Ka Wide
All Threat	Displays if more than one radar signals are detected at the same time. The signal with the strongest radar signal is considered the main signal; the other signals are displayed on the left side (See page 10).	All Threat On All Threat Off (Default)
Color	Select screen text color.	Blue (Default) Amber Green Pink Grey Red
Scan (GPS on)	Search for frequencies. <b><i>When Scan is off, time displays. R3 receives time from GMT and Daylight Savings Time; both are set in the menus.</i></b>	On Off (Default)
Display (GPS on)	Lets you select various attributes to display on the OLED.	Speed (Default) Spd+ Compass Compass Voltage Altitude
Speed Unit (GPS on)	Select the speed measurement type.	mph (Default) km/h
Auto Mute	Auto Mute reduces alarm level to 1 after 3 seconds and returns to normal operation (Auto Mute = OFF) 10 seconds after the alert ends. If the same alarm sounds within the 10 second period, Auto Mute remains at level 1. The unit returns to normal operation (Auto Mute = OFF) if a different band is detected during Auto Mute = ON mode.	On (Default) Off
Backlight	Turns the front key backlight on and off. <b><i>Press and hold MUTE/DIM to select a brightness level.</i></b>	On (Default) Off
Quiet Ride (GPS on)	Mutes radar alarms for K and X bands when you drive under the speed limit you set here.	5 - 90 in 5 mph (8 - 144 in km/h) intervals Off (Default)
Limit Speed (GPS on)	Set an alarm to sound if you go faster than this selected speed.	50 - 100 mph (80 - 160 km/h) Off (Default)

MENU ITEM	WHAT IT DOES	SETTINGS
GMT (GPS on)	Sets time zone according to Greenwich Mean Time (GMT).	Most common time zone settings for North America are: <ul style="list-style-type: none"> <li>• GMT-05:00 - Eastern Standard</li> <li>• GMT-06:00 - Central Standard</li> <li>• GMT-07:00 - Mountain Standard</li> <li>• GMT-08:00 - Pacific Standard</li> <li>• GMT-09:00 - Yukon Standard</li> <li>• GMT-10:00 - Alaska-Hawaii Standard</li> </ul>
DST (GPS on)	Daylight Saving Time	On Off (Default)
BAT Warning	Sounds a warning tone if the vehicle battery power drops below 11V.	On Off (Default)
BAT Saver (GPS on)	Turns off power to the R3 if the speed stays at 0 or if the GPS is not connected for more than an hour.	On Off (Default)
Self Test	Runs a self diagnostic test on the unit to check for faults.	On (Default) Off
Factory Reset?	Resets all settings to the factory defaults. <b><i>There is no confirmation request for reset.</i></b>	Press <b>MENU</b> to reset to factory settings.
Delete All Mute? (GPS on)	Delete all saved Mute Memory points. <b><i>There is no confirmation request to delete all Mute Memory points.</i></b>	Press <b>MENU</b> to delete Mute Memory points.
Delete All User (GPS on)	Delete all user-selected memory points.	Press <b>MENU</b> to delete.
Version	Displays the latest firmware version.	NA
DB Ver (GPS on)	Displays the latest database version.	NA
Exit	Closes the Menu system.	NA

## BASIC OPERATIONS

HOW DO I ...?	TRY THIS...
Turn on the R3	Be sure the unit is connected to power and then press <b>POWER</b> . The unit turns on and runs through an initial self-check if Self Test is turned on. It displays the different bands and their settings.  <b><i>The R3 turns on automatically when you start the vehicle.</i></b>
Adjust the volume	<ul style="list-style-type: none"> <li>• Press <b>VOL +</b> to increase volume. The unit beeps and displays a number increase.</li> <li>• Press <b>VOL –</b> to decrease volume. The unit beeps and displays a number decrease.</li> </ul>
Mute alarm audio during the alert	Press <b>MUTE/DIM</b> during an audio alarm to mute it. (This is especially useful in situations where the alert may be prolonged, such as at red lights.) You can also press the <b>MUTE</b> button on the charger (see page 8).
Change the screen's brightness	Press and hold <b>MUTE/DIM</b> . The R3 announces the brightness level (Bright, Dim, Dimmer, Dark, or Off) as it changes to that level. Press and hold the key again to cycle between the brightness levels.

HOW DO I ...?	TRY THIS...
Turn bands on and off	Press <b>MENU</b> and cycle through the menu options until the band you want to turn off displays. Press <b>MENU</b> again to change that band's status.
Change Highway to City or City 2 and back	Press <b>MENU</b> . The first menu selection is Highway (default). Press <b>MENU</b> to cycle through Highway, City, and City 2. After you select an option, press and hold <b>MENU</b> to exit. See page 10 for detailed information.
Set a user mark	Press <b>MARK</b> to create a user mark when you are at a location where there is normally some type of radar. The R3 announces "User mark logged." The R3 will announce when you approach user marks.  <b><i>The R3 can save up to 200 user marks.</i></b>
Delete a user mark	Press <b>MARK</b> again at that location to delete the user mark.  <b><i>The R3 does NOT ask for confirmation before deleting single user marks.</i></b>
Delete ALL user marks	Press and hold <b>MARK</b> to delete all user marks.  <b><i>The R3 DOES ask for confirmation before deleting all user marks. Press MARK again to confirm.</i></b>
Update the firmware and database	Refer to <a href="http://www.unidensupport.com">www.unidensupport.com</a> for details.

## FEATURE DETAILS

### USER MARKS (LASER AND RADAR SITES)

With the R3, you can mark geographical points where you commonly encounter radar transmissions, These can be school zones, red-light cameras, and places where police frequently monitor traffic.

When you are at the location, press **MARK**. The R3 announces "User mark logged." Now, when you approach these points, the R3 announces "User mark ahead."

Press and hold **MARK** at that location to delete that user mark.

The R3 registers up to 200 user marks.

### HIGHWAY VS CITY MODE

Uniden's R3 radar detector operates in three different frequency (X, K, and Ka band) sensitivity modes - Highway, City, and City 2. Highway mode is the most sensitive, with maximum detection ranges while on the highway or open road. City and City 2 are on the lower end of the detection scale for city driving. These two modes reduce sensitivity so that false signals (such as from automatic door openers) are filtered out.

Under factory default conditions (X band = off on all bands, K and Ka bands = on), the band sensitivities are:

- Highway: X band off; K and Ka band full sensitivity.
- City: X band off and K band sensitivity reduced; Ka band full sensitivity.
- City 2: X band off. K band sensitivity reduced. Ka full sensitivity.

Turn X band on in the menus with K and Ka bands still on (default); the mode sensitivities are:

- Highway: X, K, and Ka band full sensitivity.
- City: X and-K band sensitivity reduced; Ka band full sensitivity.
- City 2: X band off. K band sensitivity reduced. Ka band full sensitivity.

***If a band is turned off through the menus, it is off in all modes; however, X band is always off in City 2 mode, regardless of menu setting.***

### POP MODE

In POP mode, the R3 can detect short burst from radars that are too fast for many other detectors to catch. You can turn POP mode on and off in the Menu system.

### ALARM PRIORITIES

- GPS Connected / GPS Error / Speed Camera / Red Light Camera / User Mark Alarm/POI Limit Speed Alarm
- Laser signal



- X, K, Ka band signal

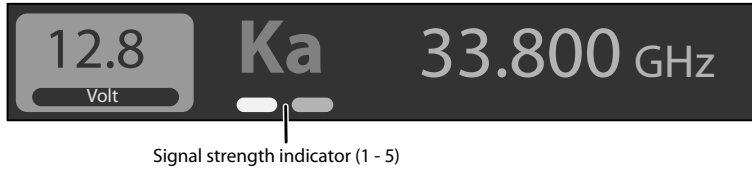

- User Limit Speed Alarm
- Vehicle Low Battery Voltage Warning, Vehicle Battery Saver Alarm



## THREAT

The R3 detects up to 4 radar band signals (threats) at a single time. The strongest radar signal is designated as the Priority signal, and its frequency displays on the OLED. The other signals (threats) are indicated in the left side of the display. In the following example, 2 K band, 1 X band, and 1 Ka band frequencies are detected.



## MUTE MEMORY

Use Mute Memory to mute known areas of false alarms (such as department store automatic doors). The R3 remembers where you muted the audio (GPS location) and the frequency you muted. It will automatically mute when you travel to that location and the saved frequency is detected; however, if a different frequency is detected, the R3 alerts to that different frequency.

When you press **MUTE/DIM** or the MUTE button on the charger to mute audio for a specific location, *Mute On* displays. While *Mute On* displays, press **MUTE/DIM** or the MUTE button on the charger again to save that GPS location to memory. *Mute Memory* displays on the screen.

***R3 stores up to 200 Mute Memory points.***

To delete Mute Memory points, press **MUTE/DIM** or the MUTE button on the charger while *Mute Memory* displays. The R3 displays a delete confirmation message; press **MUTE/DIM** or the MUTE button on the charger again to confirm. You can also delete Mute Memory points from *Menus/Delete All Mute?*

## AUTO MUTE

When the R3 detects a signal, it sounds an alarm at the current volume level. To make the alarm quieter, turn Auto Mute on through the menus. This will reduce the volume to VOL level 1 after the first 3 seconds. Auto Mute ends 10 seconds after the alarm ends unless:

- The same signal is detected within that 10 second period; then, Auto Mute stays on.
- A different band signal is detected during that 10 second period; then, Auto Mute turns off and then back on at the current volume level.

***Auto Mute does not apply to Laser Alert.***

## USER SPEED LIMIT

When you set a speed limit through the menus, the R3 sends an alarm tone if your speed exceeds that speed limit setting. If that happens, the unit announces and displays over speed warnings.

## QUIET RIDE

This function mutes X and K band radar alarms when you drive under a speed limit set in this menu (up to 90 mph/140 km/h). If X or K band signals are detected, the unit beeps once in volume level one and then goes to volume level zero. *Q-Ride* flashes in green on the OLED.

***Ka and Laser bands are NOT muted. Mute Memory overrides Quiet Ride.***

## MAINTENANCE

### MAINTAINING THE EQUIPMENT

The R3 requires very little physical maintenance. Wipe it with a soft cloth to keep dust from accumulating. Check the power cord connections to keep them clean and free of corrosion.

### UPDATING THE FIRMWARE/DATABASE

Uniden recommends that you update your R3 firmware and database periodically. Go to [www.unidensupport.com](http://www.unidensupport.com), find your model, and check if you have the latest firmware.

## TROUBLESHOOTING

IF...	TRY THIS...
The unit won't turn on.	Check the connections. Be sure they are all secure.
No display or audio.	<ul style="list-style-type: none"><li>• If no display, check the connections. Be sure they are all secure.</li><li>• If no audio, check if Voice is turned off.</li></ul>
The unit alarms when the vehicle hits bumps.	Check the connections. Be sure they are all secure.
The unit alarms briefly in the same location but no radar source was in view.	There may be a motion sensor or house alarm in use within range.
The R3 did not alert when a police car was in view.	<ul style="list-style-type: none"><li>• The officer may not have radar/laser units turned on.</li><li>• Check that the band is turned on. Press <b>MENU</b> and cycle through the options to get to the bands. If the band is turned off, the OLED will show OFF. Turn the band on.</li></ul>
The vehicle starts but the R3 does not turn on.	<ul style="list-style-type: none"><li>• Verify that the power cord is securely connected to the unit and inserted into the cigarette lighter jack.</li><li>• Change the fuse in the power cord (spare fuse not included). Unscrew the cigarette lighter plug to access the fuse.</li></ul>

## SPECIFICATIONS

Receiver Type:		Antenna Type:	
Radar	Double Conversion Superheterodyne Self-Contained Antenna	Radar	Linear Polarized E-vector Vertical
Laser	Pulsed Laser Signal Receiver	Laser Front Back	Convex Condenser Lens Concave Condenser Lens
Frequency:			
X	10.525 GHz	Dimensions	110.00 mm (D) x 69.00 mm (W) x 29.50 mm (H)
K	24.150 GHz	Weight	4.9 oz (140 g)
Ka	33.400 - 36.000 GHz	Operating Temp.	-4° to +185° F (Radar/Laser) -20° to +85° C (Radar/Laser)
Laser	800 nm - 1100 nm	Storage Temp.	-22° to +203° F (Radar/Laser) -30° to +95° C (Radar/Laser)

Detector Type:		Operating Power Source	DC 11.0 to 16.0 V
Radar	Scanning Frequency Discriminator	USB Interface	USB Specification 2.0/1.1
Laser	Pulse Width Discriminator		
Alarm Type	Beep (Detected Band and Signal strength)		

## FCC/IC COMPLIANCE

FCC: AMWUA1702

### FCC Compliance

This device complies with Part 15 of the FCC rules. Operation is subjected to the following two conditions: (1) this device may not cause harmful interference, and (2) this device must accept any interference received, including interference that may cause undesired operation.

Changes or modifications not expressly approved by the party responsible for compliance could void your authority to operate the equipment.

Avis de conformité à la FCC : Ce dispositif a été testé et s'avère conforme à l'article 15 des règlements de la Commission fédérale des communications (FCC). Ce dispositif est soumis aux conditions suivantes: 1) Ce dispositif ne doit pas causer d'interférences nuisibles et; 2) Il doit pouvoir supporter les parasites qu'il reçoit, incluant les parasites pouvant nuire à son fonctionnement.

Tout changement ou modification non approuvé expressément par la partie responsable pourrait annuler le droit à l'utilisateur de faire fonctionner cet équipement.

### IC Compliance

This device complies with Industry Canada license-exempt RSS standard(s). Operation is subject to the following two conditions: (1) this device may not cause interference, and (2) this device must accept any interference, including interference that may cause undesired operation of the device.

Changes or modifications not expressly approved by the party responsible for compliance could void your authority to operate the equipment.

Cet appareil est conforme aux normes RSS exemptes de licences d'Industrie Canada. Son fonctionnement est soumis aux deux conditions suivantes : (1) cet appareil ne doit pas causer d'interférences nuisibles et (2), il doit pouvoir accepter les interférences, incluant celles pouvant nuire à son fonctionnement normal.

Tout changement ou modification non approuvé expressément par la partie responsable pourrait annuler le droit à l'utilisateur de faire fonctionner cet équipement.

## ONE-YEAR LIMITED WARRANTY

***Keep your receipt! Proof of purchase is required for warranty service.***

### WARRANTOR: UNIDEN AMERICA CORP. ("Uniden")

ELEMENTS OF WARRANTY: Uniden warrants, for one year, to the original retail owner, this Uniden Product to be free from defects in materials and craftsmanship with only the limitations or exclusions set out below.

WARRANTY DURATION: This warranty to the original user shall terminate and be of no further effect 12 months after the date of original retail sale. The warranty is invalid if the Product is (A) damaged or not maintained as reasonable or necessary, (B) modified, altered, or used as part of any conversion kits, subassemblies, or any configurations not sold by Uniden, (C) improperly installed, (D) serviced or repaired by someone other than an authorized Uniden service center for a defect or malfunction covered by this warranty, (E) used in any conjunction with equipment or parts or as part of any system not manufactured by Uniden, or (F) installed or programmed by anyone other than as detailed by the Operating Guide for this product.

STATEMENT OF REMEDY: In the event that the product does not conform to this warranty at any time while this warranty is in effect, warrantor will repair the defect and return it to you without charge for parts, service, or any other cost (except shipping and handling) incurred by warrantor or its representatives in connection with the performance of this warranty. THE LIMITED WARRANTY SET FORTH ABOVE IS THE SOLE AND ENTIRE WARRANTY PERTAINING TO THE PRODUCT AND IS IN LIEU OF AND EXCLUDES ALL OTHER WARRANTIES OF ANY NATURE WHATSOEVER, WHETHER EXPRESS, IMPLIED OR ARISING BY OPERATION OF LAW, INCLUDING, BUT NOT LIMITED TO ANY IMPLIED WARRANTIES OF MERCHANTABILITY OR FITNESS FOR A PARTICULAR PURPOSE. THIS WARRANTY DOES NOT COVER OR PROVIDE FOR THE REIMBURSEMENT OR PAYMENT OF INCIDENTAL OR CONSEQUENTIAL DAMAGES. Some states do not allow this exclusion or limitation of incidental or consequential damages so the above limitation or exclusion may not apply to you.



LEGAL REMEDIES: This warranty gives you specific legal rights, and you may also have other rights which vary from state to state. This warranty is void outside the United States of America.

PROCEDURE FOR OBTAINING PERFORMANCE OF WARRANTY: If, after following the instructions in this Operating Guide, you are certain that the Product is defective, pack the Product carefully (preferably in its original packaging). Include evidence of original purchase and a note describing the defect that has caused you to return it. The Product should be shipped freight prepaid, by traceable means, or delivered, to warrantor at:

Uniden America Corporation  
C/O Saddle Creek  
743 Henrietta Creek Rd., Suite 100  
Roanoke, TX 76262

POP Mode is a trademark of MPH Industries, Inc.

Spectre I and Spectre IV are trademarks of Stealth Micro Systems Pty. Ltd.





