

Baofeng UV-5R

The (Chinese) Radio Documentation Project

<http://radiodoc.github.com/>

Lennart Lidberg

Baofeng UV-5R: The (Chinese) Radio Documentation Project: <http://radiodoc.github.com/>

by Lennart Lidberg

Copyright © 2012 Lennart Lidberg

This work is licensed under the Creative Commons Attribution-ShareAlike 3.0 Unported License.

You are free:

- to Share — to copy, distribute and transmit the work
- to Remix — to adapt the work
- to make commercial use of the work

Under the following conditions:

- Attribution — You must attribute the work in the manner specified by the author or licensor (but not in any way that suggests that they endorse you or your use of the work).
- Share Alike — If you alter, transform, or build upon this work, you may distribute the resulting work only under the same or similar license to this one.

With the understanding that:

- Waiver — Any of the above conditions can be waived if you get permission from the copyright holder.
- Public Domain — Where the work or any of its elements is in the public domain under applicable law, that status is in no way affected by the license.
- Other Rights — In no way are any of the following rights affected by the license:
 - Your fair dealing or fair use rights, or other applicable copyright exceptions and limitations;
 - The author's moral rights;
 - Rights other persons may have either in the work itself or in how the work is used, such as publicity or privacy rights.

To view a copy of this license, visit

<http://creativecommons.org/licenses/by-sa/3.0/>

or send a letter to

Creative Commons,
559 Nathan Abbott Way,
Stanford, California 94305, USA.

All brand names and trademarks mentioned in this document is the property of their respective holders. The authors of this document shares no affiliation with any of the brands and trademarks mentioned within this document.

The (Chinese) Radio Documentation Project or its authors does not hold any responsibility or liability for any damage or injury, direct, indirect or otherwise caused as a result of following the instructions and procedures herein.

Table of Contents

Preface	vii
I. Getting started	1
1. Initial setup	3
What's in the box	3
Assembly	3
Antenna	3
Belt clip	3
Battery	4
Charging and battery maintenance	4
Charging	4
Battery Maintenance	5
2. Getting to know your radio	7
The main display	8
Battery Level Indicator	9
Status LED	9
Side key 1 - CALL (Broadcast FM and Alarm)	9
Side key 2 - MONI (Monitor and Flashlight)	9
VFO / MR -mode key	9
A / B select key	9
Band key	10
Numeric keypad	10
Pound key	10
Star key	11
Menu and function keys	11
Accessory jack	11
3. Basic Use	13
Power and volume	13
Turning the unit on	13
Turning the unit off	13
Adjusting the volume	13
Making a call	14
Channel selection	14
Frequency (VFO) mode	14
Channel (MR) mode	15
II. Advanced topics	17
4. Working the menu system	19
Basic use	19
Using short-cuts	19
5. Scanning	21
Scanning modes	21
Time operation	21
Carrier operation	21
Search operation	21
Tone Scanning	22

6. Dual Watch	23
7. DTMF	25
8. Selective calling	27
CTCSS	27
DCS	28
1750Hz Tone-burst	29
9. Customization	31
Display	31
Power-on message	32
10. Programming	33
Manual programming	33
Simplex channels	33
Duplex channels	34
Computer programming	34
Attaching the programming cable	34
Baofeng software	34
Radio to radio cloning	36
III. How-to and setup guides.	39
11. Repeaters	41
12. Automatic Number Identification	43
13. Application Specific Setup	45
Commercial Radio Setup	45
Amateur Radio Setup	45
MilSim: Airsoft and Paintball	46
A. Troubleshooting	47
B. Menu definitions	49
0 SQL - Squelch Level	49
1 STEP - Frequency Step	49
2 TXP - Transmit Power	49
3 SAVE - Battery Save	49
4 VOX - Voice Operated TX	50
5 WN - Wideband / Narrowband	50
6 ABR - Display Illumination Time	50
7 TDR - Dual Watch	50
8 BEEP - Keypad Beep	51
9 TOT - Transmission Time-out-Timer	51
10 R-DCS - Receiver DCS	51
11 R-CTCS - Receiver CTCSS	51
12 T-DCS - Transmitter DCS	52
13 T-CTCS - Transmitter CTCSS	52
14 VOICE - Voice Prompt	52
15 ANI-ID - Automatic Number ID	53
16 DTMFST - DTMF tone of transmit code	53
17 S-CODE - Signal Code	53
18 SC-REV - Scanner Resume Method	53
19 PTT-ID - When to send the PTT-ID	54

20 PTT-LT - Signal code sending delay	54
21 MDF-A - Channel Mode A Display	54
22 MDF-B - Channel Mode B Display	55
23 BCL - Busy Channel Lock-out	55
24 AUTOLK - Automatic Keypad Lock	55
25 SFT-D - Frequency Shift Direction	55
26 OFFSET - Frequency shift amount	56
27 MEM-CH - Store a Memory Channel	56
28 DEL-CH - Delete a memory channel	56
29 WT-LED - Display back-light colour, Standby	56
30 RX-LED - Display back-light colour, Receive	57
31 TX-LED - Display back-light colour, Transmit	57
32 AL-MOD - Alarm Mode	57
33 BAND - Band Selection	57
34 TDR-AB - Transmit selection while in Dual Watch mode	58
35 STE - Squelch Tail Elimination	58
36 RP-STE - Squelch Tail Elimination through a repeater	58
37 RPT-RL - Delay the squelch tail of repeater	58
38 PONMGS - Power On Message	59
39 ROGER - Roger Beep	59
40 RESET - Restore defaults	59
C. Technical specifications	61
General	61
Transmitter	61
Receiver	62
DCS table	62
CTCSS table	63

Preface

Lennart Lidberg
November 10th, 2012.

Please excuse the crudity of this model. I didn't have time to build it to scale or paint it.

—Dr. Emmet Brown

This manual started out as a bit of a joke between friends, saying that "Someone should write a better manual!". As it turns out, that someone turned out to be I.

Never having written any real documentation before (aside from short how-to documents online), I turned to the masters of documentation themselves for inspiration; O'Reilly Media and the Safari books. After reading around on their website I stumbled upon their design guideline documents, and in turn stumbled onto DocBook [<http://docbook.org/>] - an entire format designed for writing documentation - perfect.

As a result this manual is a bit rough around the edges. A learning exercise using essentially defaults from the DocBookXSL stylesheet collection. However, despite not having the polish of a professional publication, the content should be the best it can be.

Many thanks to all of those who donated to make this possible. Also big thanks to O'Reilly Media for their inspiration and wonderful documentation.

Regarding CHIRP and the upcoming revised edition

Originally I intended to include a whole section in the programming chapter dedicated to the free and open source programming tool CHRIP [<http://chirp.danplanet.com/>], but unfortunately I couldn't for the life of me get it playing with my hardware, despite trying three entirely different setups.

CHIRP will therefore have to wait for the revised edition of the book, which in turn will have to wait for me to get CHIRP working. Other than the addition of CHIRP and inclusion of any errata from this edition, the revised edition will include the Glossary and Index sections that were cut due to time concerns (unfortunately I didn't have the foresight to index things as I was writing them as I was still learning about how to use DocBook). There is a high probability that I will further refine the book's layout and design as well.

Part I. Getting started

Part one covers the basic setup and use of your hand-held two-way transceiver.

Chapter 1, *Initial setup*

Chapter 2, *Getting to know your radio*

Chapter 3, *Basic Use*

Chapter 1. Initial setup

What's in the box

This transceiver comes shipped with the following items in the box:

- Radio body
- Lithium-Ion battery pack
- Antenna
- Desk charger (With accompanying wall-wart)
- Optional belt clip
- Optional wrist-strap



Items included may vary depending on country of purchase. For further information please contact your local vendor or dealer.

Assembly

Before the radio is ready for use we need to attach the antenna and battery pack, as well as charge the battery.

Antenna

This transceiver is fitted with a Male SMA connector. To mount your antenna (Female SMA connector), align the two connectors and turn clockwise until it stops.



- Do not over-tighten your antenna to avoid damage to the connectors.
- When installing the antenna, don't grip it by the top. Grip by the base and turn.
- If you use an external antenna, make sure the *SWR* is about 1.5:1 or lower to avoid damage to the transceiver.
- Do not hold the antenna with your hand or wrap the outside of it to avoid bad operation of the transceiver.
- Never transmit without an antenna.

Belt clip

At the back of the radio there are two parallel screws mounted above the battery, remove these and thread them through the holes on the belt clip as you screw them back into the radio body.



Do not use any form of glue to fix the screws on the battery clip. The solvents in the glue may cause damage to the battery casing.

Battery

Before attaching or removing the battery make sure your radio is turned off by turning the power/volume knob all the way counter-clockwise.

Installation

Make sure the battery is aligned in parallel with the radio body with the lower edge of the battery about 1-2cm below the edge of the radio.

Once aligned with the guide-rails, slide the battery upward until you hear a click as the battery locks in place.

Removal

To remove the battery, press the battery release above the battery pack (see Figure 2.1, “Baofeng UV-5R, overview”), as you slide the battery downward.

Charging and battery maintenance



For optimum battery efficiency, cycle the battery at least three times before regular use.

A cycle consists of fully charging the battery (about five hours charge time with a standard battery) and then fully depleting it before charging it again.

Charging

Follow these steps to hook up and use the charger:

1. Plug the DC connector of the power adaptor into the charger base.
2. Plug the AC connector of the power adaptor into a mains wall socket.
3. Place the radio in the charging slot on the charger.
4. Make sure the radio is making contact with the charger. When the the red LED comes on steady, your radio is charging.
5. The radio is fully charged once the charger's green status LED goes steady. Please remove the radio at that time to avoid over-charging your battery.

Table 1.1. Charger LED codes

Red LED	Green LED	Status
flashing	steady	Standby (charger empty) Error (charger with radio)
steady	off	Charging
off	steady	Charge complete.



The charger and battery are fitted with matching notches so that you can charge your battery on its own! Practical if you have two batteries. That way you can charge one battery while still using your radio.

Battery Maintenance

The battery for your radio comes uncharged from the factory, please let it charge for at least four to five hours before you start using your radio.



- Use only batteries approved by the original manufacturer.
- Never attempt to disassemble your battery pack.
- Do not expose your batteries to fire or intense heat.
- Dispose of batteries in accordance with local recycling regulations. Batteries do not belong in your trash can!

Prolonging the life of your battery

- Only charge batteries in normal room temperatures.
- When charging a battery attached to the radio, turn the radio off for a faster charge.
- Do not unplug the power to the charger or remove the battery and/or radio before it's finished charging.
- Never charge a wet battery.
- Batteries wear out over time. If you notice a considerably shorter operating time with your radio, please consider purchasing a new battery.
- Battery performance will be reduced in temperatures below freezing. When working in cold environments, keep a spare battery on you. Preferably inside your jacket or in a similar location in order to keep the battery warm.
- Dust can interfere with the contacts on the battery. If necessary wipe the contacts with a clean cloth to ensure proper contact with radio and charger.



If your battery has become wet, remove it from the radio, wipe it dry with a towel and put it in a plastic bag with a handful of dry rice. Tie the bag up and let it sit over night. The rice will absorb any remaining moisture in the battery.

This method is only effective against minor splashes (light rain for instance). A soaked radio may very well be beyond repair.

Storage

Fully charge your battery before long time storage in order to prevent damage from over-discharge.

To avoid severe capacity degradation of your battery while in long time storage, please cycle the battery at least every six(6) months.

Store your batteries in a cool and dry place, never above normal room temperatures.

Chapter 2. Getting to know your radio

Figure 2.1. Baofeng UV-5R, overview

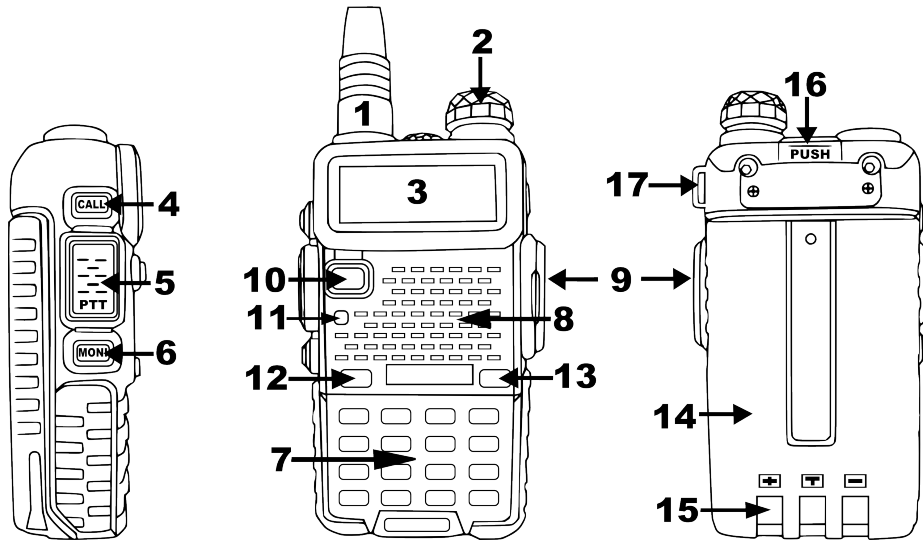

1. Antenna, see the section called “Assembly” for details.
2. Power / Volume knob, usage discussed in the section called “Power and volume”.
3. Two-line LCD
4. Call key
5. PTT key, usage discussed in the section called “Making a call”.
6. Monitor key
7. Keypad
8. Speaker and microphone
9. Accessory jack
10. VFO/MR mode key
11. Status LED
12. A / B select key
13. Band select key
14. Battery pack, see the section called “Charging and battery maintenance” for details.
15. Battery contacts
16. Battery release latch
17. Lanyard loop
18. LED flashlight, (not marked) situated between antenna and power/volume knob. See the section called “Side key 2 - MONI (Monitor and Flashlight)” for more information.

The main display

Figure 2.2. Baofeng UV-5R, display



The transceiver is fitted with a seven character by two line dot-matrix alphanumeric LCD, with auxiliary icons for miscellaneous features.

Table 2.1. LCD icon summary

Icon	Description
188	Memory channel
25, 75	Least significant modifiers.
CT	CTCSS enabled
DCS	DCS enabled
+, -	Frequency shift direction if enabled
S	Dual watch enabled
VOX	VOX enabled
R	Reverse function enabled
N	Narrowband enabled
	Battery level indicator
	Keypad lock enabled
L	Transmit power set to Low
	Indicates active band or channel
	Signal Strength Meter

Unmentioned icons seems to not be implemented in this model of radio.



Even though it is a seven character by two line display, channel memories are only configurable to six character names.

Battery Level Indicator

When the battery level indicator reads  the battery is depleted. At this point the radio will start beeping periodically as well as flash the backlight of the display, indicating that you need to change your battery or put your radio in the charger.

Status LED

The status LED has a very simple and traditional design. When you receive a signal it turns green, when you transmit it turns red, and it's off in standby.

Side key 1 - CALL (Broadcast FM and Alarm)

Press **CALL** momentarily to start the broadcast FM receiver. Another momentary press turns the broadcast FM receiver off.

Press and hold **CALL** to activate the alarm function. Press **CALL** again to turn it off.

Side key 2 - MONI (Monitor and Flashlight)

Press **MONI** momentarily to turn on the LED flashlight. Another momentary press turns the flashlight off.

Press and hold **MONI** to monitor the signal. This will open up the squelch so you can listen to the unfiltered signal.

VFO / MR -mode key

Pressing **VFO/MR** switches between Frequency (VFO) Mode and Memory (MR) mode. Memory mode is sometimes also referred to as Channel mode.

To save frequencies to channel memory you must be in Frequency (VFO) mode.

A / B select key

The **A/B** key switches between A (upper) and B (lower) displays. The frequency or channel on the selected display becomes the active listening and transmit frequency or channel.

To save frequencies to channel memory you must be on the A display.

Band key

The **BAND** key switches between VHF and UHF bands when in Frequency (VFO) mode.

When listening to broadcast FM, the **BAND** key switches between 65-75 MHz and 76-108 MHz bands.

Numeric keypad

The Baofeng UV-5R hand-held transceiver comes standard with a full numeric keypad.

Figure 2.3. Baofeng UV-5R, keypad



The numeric keys have their secondary function printed on them (in reality it's rather menu short-cuts, more on that in Chapter 4, *Working the menu system*).

The ***SCAN** and **#r•** keys on the other hand have actual secondary functions, scan and keypad lock respectively.

Pound key

In channel mode, **#r•** also acts as a transmit power short key. While in channel mode, momentarily press **#r•** to change between High and Low transmit power. Do note that this does not alter the transmit power stored to memory for that channel, it only affects the current session. Switching to another channel or another operating mode (including broadcast FM) will reset transmit power to what's stored in channel memory.

Keypad Lock

The Baofeng UV-5R features a keypad lock that locks out all keys except for the three side keys.

To enable or disable the keypad lock, press and hold the **#r•** key for about two seconds.

You can also enable so that the radio automatically locks the keypad after ten seconds from the menu, see Chapter 4, *Working the menu system* and ??? in Appendix B, *Menu definitions* for details.

Star key

A short momentary press of the key enables the reverse function (see Chapter 11, *Repeaters*).

When listening to broadcast FM a momentary press will start the scanning. Scanning in broadcast FM will stop as soon as an active station is found, regardless of scanner resume method.

To enable the scanner, press and hold the **[*SCAN]** key for about two seconds. See Chapter 5, *Scanning* for details.

Menu and function keys

The **[MENU]** key, used to enter the menu and confirm menu options.

The **[▲]** and **[▼]** keys are used to navigate through the menu as well as select channels and step up or down in frequency (depending on operating mode).

The **[EXIT]** key is used to exit menus and cancel menu options.

For a more in-depth explanation on how to work the menu see Chapter 4, *Working the menu system*.

Accessory jack

The accessory jack on the Baofeng UV-5R is a Kenwood compatible two(2)-pin design.

Figure 2.4. Typical 2 pin Kenwood headset configuration.

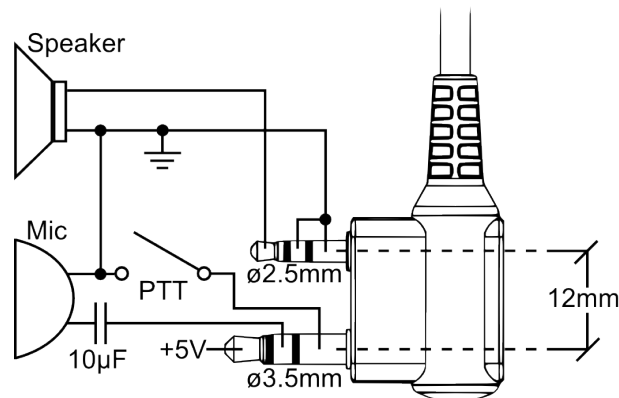

The Kenwood 2-pin connector has one 3.5mm TRS plug, and one 2.5mm TS plug, spaced 12mm apart.

To attach accessories such as headsets, speaker-mics or programming cables, align the connectors and push in fully.

The fit isn't always perfect on cheap cables and connectors and may require a bit of force to wiggle them in completely.



Make sure the radio is off before attaching any accessories.

Chapter 3. Basic Use

Power and volume

Before we turn the power on, make sure you have attached the battery and antenna as described in Chapter 1, *Initial setup*.

Turning the unit on

To turn the unit on, simply rotate the volume/power knob clockwise until you hear a "click". If your radio powers on correctly there should be an audible double beep and the display and backlight should turn on, looking something like this:

Figure 3.1. First power-on, display

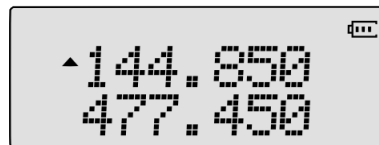

You can get additional information about your radio when you turn it on by holding down miscellaneous keys as you turn it on.

Holding down the **(3SAVE)** key while turning on the radio provides you with the firmware version.

Holding down the **(6ABR)** key while turning on the radio provides you with what is most likely a control or manufacturing date and a hardware revision number. (It should be noted that this is not confirmed and pure speculation from the community.)

Turning the unit off

Turn the volume/power knob counter-clock wise all the way until you hear a "click". The unit is now off.

Adjusting the volume

To turn up the volume, turn the volume/power knob clock-wise.

To turn the volume down, turn the volume/power knob counter-clock-wise. Be careful not to turn it too far, as you may inadvertently turn your radio off.



By using the monitor function, enabled from the **(MONI)** key below the PTT, you can more easily adjust your volume by adjusting it to the un-squelched static.

Making a call

Press and hold the PTT button on the side of the radio body to transmit. While transmitting, speak approximately 3-5cm from the microphone. When you release the PTT your transceiver will go back to receive mode.

Channel selection

There are two modes of operation. Frequency (VFO) mode, and Channel or Memory (MR) mode.

For everyday use, Channel (MR) mode is going to be a whole lot more practical than Frequency (VFO) mode. However, Frequency (VFO) mode is very handy for experimentation out in the field. Frequency (VFO) mode is also used for programming channels into memory. For details on how to program your transceiver see Chapter 10, *Programming*.

Ultimately which mode you end up using will depend entirely on your use case.

Frequency (VFO) mode

In Frequency (VFO) mode you can navigate up and down the band by using the **(▲)** and **(▼)** keys. Each press will increment or decrement your frequency according to the frequency step you've set your transceiver to. For details on how to set the frequency step on your transceiver see Chapter 4, *Working the menu system* and the section called “1 STEP - Frequency Step” in Appendix B, *Menu definitions*.

You can also input frequencies directly on your numeric keypad with kilohertz accuracy. However, the radio will floor to the nearest frequency that correspond to your frequency step. In other words, when you input frequencies with greater than 1kHz resolution (such as 145.6875 MHz in the example below), always round your input up.

The following example assumes the use of a 12.5kHz frequency step.

Example 3.1. Entering the frequency 145.6875 MHz on display A

1. Use the **(VFO/MR)** key to switch to Frequency (VFO) mode
2. Press **(A/B)** until the **(▲)** appears next to the upper display (display A).
3. Press the **(BAND)** key until you get to VHF. The display should read somewhere between 136 and 174 MHz.

4. Enter **1STEP** **4VOX** **5WV** on the numeric keypad, it should look something like this:

Figure 3.2. Half-entered frequency input.

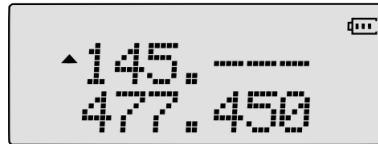

5. Now, for the final four digits. Note that you can only enter three decimals on the keypad, if you type 687 it wont work. So how do you get the fourth and final digit 5 in there? By rounding 145.6875 up to 145.6880 MHz.

Enter **6ABR** **8BEEP** **8BEEP** on the numeric keypad, if all went well the display should look something like this:

Figure 3.3. Successful frequency input

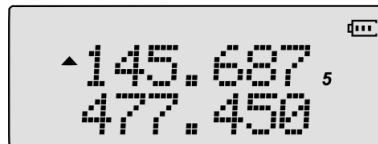

Just because you can program in a channel does not mean you're automatically authorized to use that frequency.

Transmitting on frequencies you're not authorized to operate on is illegal, and in most jurisdictions a serious offence. If you get caught transmitting without a license you can and will get fined, and in worst case sent to jail.

However, it is legal in most jurisdictions to listen. Contact your local regulatory body for further information on what laws, rules and regulations apply to your area.

Channel (MR) mode

The use of Channel (MR) mode is dependent on actually having programmed in some channels to use. To find out more on how to program channels see Chapter 10, *Programming*.

Once you have channels programmed and ready, you can use the **▲** and **▼** keys to navigate between channels.



If you have channels programmed with Transmit power set to Low, you can use the **#r** key to momentarily switch over to high power if you're having trouble getting through.

Part II. Advanced topics

Part two covers the more advanced topics, such as setup of repeater offset and programming via computer link.

Chapter 4, *Working the menu system*

Chapter 5, *Scanning*

Chapter 6, *Dual Watch*

Chapter 7, *DTMF*

Chapter 8, *Selective calling*

Chapter 9, *Customization*

Chapter 10, *Programming*

Chapter 4. Working the menu system

For a complete reference on available menu items and parameters, see Appendix B, *Menu definitions*.



If your radio is set to Memory (MR) mode, the following menu items will not take any effect:

STEP, TXP, W/N, CTCSS, DCS, S-CODE, PTT-ID, BCL, SFT-D, OFFSET, MEM-CH, BAND

Basic use

Procedure 4.1. Using the menu with arrow keys

1. Press the **MENU** key to enter the menu.
2. Use the **▲** and **▼** keys to navigate between menu items.
3. Once you find the desired menu item, press **MENU** again to select that menu item.
4. Use the **▲** and **▼** keys to select the desired parameter.
5. When you've selected the parameter you want to set for a given menu item;
 - a. To confirm your selection, press **MENU** and it will save your setting and bring you back to the main menu.
 - b. To cancel your changes, press **EXIT** and it will reset that menu item and bring you out of the menu entirely.
6. To exit out of the menu at any time, press the **EXIT** key.

Using short-cuts

As you may have noticed if you looked at Appendix B, *Menu definitions*, every menu item has a numerical value associated with it. These numbers can be used for direct access of any given menu item.

The menu is also organized in such a way that the ten most common functions are on top, and as can be seen in Figure 2.3, “Baofeng UV-5R, keypad”, these are also printed on the keypad so you don't have to remember them all.

The parameters also have a number associated with them, see Appendix B, *Menu definitions* for details.

Procedure 4.2. Using the menu with short-cuts

1. Press the **MENU** key to enter the menu.
2. Use the numerical keypad to enter the number of the menu item.
3. To enter the menu item, press the **MENU** key.
4. For entering the desired parameter you have two options:
 - a. Use the arrow keys as we did in the previous section;
or
 - b. Use the numerical keypad to enter the numerical short-cut code.
5. And just as in the previous section;
 - a. To confirm your selection, press **MENU** and it will save your setting and bring you back to the main menu.
 - b. To cancel your changes, press **EXIT** and it will reset that menu item and bring you out of the menu entirely.
6. To exit out of the menu at any time, press the **EXIT** key.

All further examples and procedures in this manual will use the numerical menu short-cuts.

Chapter 5. Scanning

The Baofeng UV-5R features a built in scanner for the VHF and UHF bands. When in Frequency (VFO) mode it will scan in steps according to your set frequency step. In Channel (MR) mode it will scan your channels. At approximately three frequencies per second, it's not the fastest scanner in the world, but it is nonetheless a useful feature to have at times.

To enable the scanner, press and hold the **[*SCAN]** key for about two seconds.

Press any key to exit scanning mode.

Scanning modes

The scanner is configurable to one of three ways of operation: Time, carrier or search, each of which are explained in further details in their respective section below.

Procedure 5.1. Setting scanner mode

1. Press the **[MENU]** key to enter the menu.
2. Enter **[1STEP]** **[8BEEP]** on your numeric keypad to come to scanner mode.
3. Press the **[MENU]** key to select.
4. Use the **[▲]** and **[▼]** keys to select scanning mode.
5. Press the **[MENU]** key to confirm and save.
6. Press the **[EXIT]** key to exit the menu.

Time operation

In Time Operation (TO) mode, the scanner stops when it detects a signal, and after a pre set time out time of inactivity, it resumes scanning.

Carrier operation

In Carrier Operation (CO) mode, the scanner stops when it detects a signal, and as soon as the signal goes away it resumes scanning.

Search operation

In Search Operation (SE) mode, the scanner stops when it detects a signal.

To resume scanning you must press and hold the ***SCAN** key again.

Tone Scanning

In frequency mode you can scan for CTCSS tones and DCS codes on active frequencies.

To scan for CTCSS or DCS on active channels, follow these steps:

Procedure 5.2. Tone scanning

1. Press the **MENU** key to enter the menu.
2. Enter one of the following on the numeric keypad:
 - a. **1STEP 0SQL** to scan for DCS codes, or
 - b. **1STEP 1STEP** to scan for CTCSS sub-tones.
3. Press the **MENU** key to select.
4. Press the ***SCAN** key momentarily, CT or DCS will start flashing in the display as the radio starts scanning. Once it finds a tone or code in use, it will beep and stop flashing, indicating that a tone or code has been found.
5. Press the ***SCAN** key to confirm.
6. Press the ***SCAN** key to exit the menu system

If you wish to communicate with a party after finding out what CTCSS or DCS settings they're transmitting with, configure your transmit CTCSS or DCS according with what the scanner set for your receive CTCSS or DCS. For details see Chapter 8, *Selective calling*.

Chapter 6. Dual Watch

In certain situations, the ability to monitor two channels at once can be a valuable asset. This can be achieved in one of two ways. You can either have one receiver in your radio and flip-flop between two frequencies at a fixed interval (known as Dual Watch), or you can equip a radio with two receivers (known as Dual Receive or Dual VFO). The former method is cheaper to implement and far more common than the latter.







The Baofeng UV-5R features Dual Watch functionality (single receiver) with the ability to lock the transmit frequency to one of the two channels it monitors.



Certain functions are not available while in dual watch mode:







- You cannot use the reverse function.
- You cannot use the  key to switch between high and low transmit power in channel mode.
- You cannot save duplex channels.

Procedure 6.1. Enabling or disabling Dual Watch mode

1. Press the  key to enter the menu.
2. Enter  on the numeric keypad to get to Dual Watch.
3. Press  to select.
4. Use the  and  keys to enable or disable.
5. Press the  key to confirm.
6. Press the  key to exit the menu.

Due to the way the Baofeng UV-5R is constructed, whenever one of the A and B channels goes active, it will default to transmit on that channel. This behaviour can be highly inconvenient, especially if you're listening to a frequency you're not allowed to transmit on. Luckily there is a menu option available to lock the transmitter to one of the A and B channels.

Procedure 6.2. Locking the Dual Watch transmit channel

1. Press the  key to enter the menu.
2. Enter   on the numeric keypad to get to TDR-AB.
3. Press  to select.
4. Use the  and  keys to select A (upper) or B (lower) displays.

5. Press the **MENU** key to confirm.
6. Press the **EXIT** key to exit the menu.



If you want to momentarily override the lock without having to setting the menu option to OFF, you can do so by pressing the **A/B** key an instant before pressing the PTT.

Another option for overriding the lock momentarily, is to program in the reverse of Channel (MR) mode into Frequency (VFO) mode and using the **VFO/MR** key to swap between primary and secondary channels.

Chapter 7. DTMF







DTMF is an in-band signalling method using dual sinusoidal signals for any given code. Originally developed for telephony systems, it has proved a very versatile tool in many other areas.

In two-way radio systems, DTMF is most commonly used for automation systems and remote control. A common example would be in amateur radio repeaters where some repeaters are activated by sending out a DTMF sequence (usually a simple single-digit sequence).

Table 7.1. DTMF frequencies and corresponding codes

	1209 Hz	1336 Hz	1477 Hz	1633 Hz
697 Hz	1	2	3	A
770 Hz	4	5	6	B
852 Hz	7	8	9	C
941 Hz	*	0	#	D

The Baofeng UV-5R has a full implementation of DTMF, including the A, B, C and D codes.

The numerical keys, as well as the , and , keys correspond to the matching DTMF codes as you would expect. The A, B, C and D codes are located in the , ,  and  keys respectively.

To send DTMF codes, press the key(s) corresponding to the message you want to send while holding down the PTT key.



If you have the keypad lock enabled on your radio, you can still send DTMF tones the regular way without having to unlock your radio.

Chapter 8. Selective calling

Some times when you're working with larger groups of people using the same channel, things can get very crowded, very fast. To minimize this problem, several methods of blocking out unwanted transmissions on your frequency has developed. In general, there are two forms of selective calling in two-way radio systems: Group calling, and individual calling.

Group calling, as the name suggest, is a one-to-many form of communication. Every radio in your working group is configured the same way and any radio will make contact with every other radio in the group.

Individual calling, some times also known as paging, is a one-to-one form of communication. Every radio is programmed with a unique ID code. And only by sending out a matching code can you get that radio to open up to your transmissions.

The Baofeng UV-5R features three different ways of group calling:

- CTCSS
- DCS
- Tone-burst (1750Hz)

The Baofeng UV-5R does not feature any form of individual calling.



Using these features does NOT mean that others won't be able to listen in on your transmissions.

They only provide a method to *filter out unwanted incoming transmissions*. Any communications made while using these features will still be heard by anyone not employing filtering options of their own.

Also, you cannot change the CTCSS or DCS settings while in memory (MR) mode.

CTCSS and 1750Hz tone-burst are also popular methods among amateur radio operators to open up repeaters.

CTCSS

CTCSS is set with menus 11 R-CTCS and 13 T-CTCS.

For a complete list of available CTCSS codes and corresponding sub-tone frequencies, see Table C.2, "CTCSS Frequencies" in Appendix C, *Technical specifications*.

Procedure 8.1. CTCSS setup how-to

1. Press the  key to enter the menu.

2. Enter **1STEP** **1STEP** on the numeric keypad to get to receiver CTCSS.
3. Press **MENU** to select.
4. Enter desired CTCSS sub-tone frequency in hertz on the numeric keypad.
5. Press **MENU** to confirm and save.
6. Enter **1STEP** **3SAVE** on the numeric keypad to go to transmitter CTCSS.
7. Press **MENU** to select.
8. Enter desired CTCSS sub-tone frequency in hertz on the numeric keypad. Make sure it's the same frequency as that you entered for receiver CTCSS.
9. Press **MENU** to confirm and save.
10. Press **MENU** to exit the menu system.

To turn CTCSS off, follow the same procedure but set it to off with the **0SQL** key instead of selecting a CTCSS sub-tone frequency.

For more information see the section called “11 R-CTCS - Receiver CTCSS” and the section called “13 T-CTCS - Transmitter CTCSS” in Appendix B, *Menu definitions*.

DCS

DCS is set with menus 10 R-DCS and 12 T-DCS.

For a complete list of available DCS codes, see Table C.1, “DCS Codes” in Appendix C, *Technical specifications*.

Procedure 8.2. DCS setup how-to

1. Press the **MENU** key to enter the menu.
2. Enter **1STEP** **0SQL** on the numeric keypad to get to receiver DCS.
3. Press **MENU** to select.
4. Enter desired DCS code on the numeric keypad.
5. Press **MENU** to confirm and save.
6. Enter **1STEP** **2TXP** on the numeric keypad to go to transmitter DCS.
7. Press **MENU** to select.

8. Enter desired DCS code on the numeric keypad. Make sure it's the same code as that you entered for receiver DCS.
9. Press **MENU** to confirm and save.
10. Press **MENU** to exit the menu system.

To turn DCS off, follow the same procedure but set it to off with the **SQL** key instead of selecting a DCS code.

For more information see the section called “10 R-DCS - Receiver DCS” and the section called “12 T-DCS - Transmitter DCS” in Appendix B, *Menu definitions*.

1750Hz Tone-burst

To send out a 1750Hz tone-burst, press the **BAND** key while holding down the PTT.

No further configuration required to use this feature.



If you have the keypad lock enabled on your radio, you can still send a 1750Hz tone the regular way without having to unlock your radio.

Chapter 9. Customization

The Baofeng UV-5R allows for customization of both the power-on message (via computer link only), and the backlight colour during the three states of the transceiver (Transmit, Receive and Standby).

Display

The LCD on the Baofeng UV-5R is backlit by multi-colour LEDs, the colour of which can be pre-set from the menu system into a variety of colours.

To change the colours, follow these steps:

Procedure 9.1. Changing backlight colour

1. Press the **MENU** key to enter the menu.
2. Enter one of the following on your numeric keypad:
 - a. **2TXP 9TOT** to change the Standby colour.
 - b. **3SAVE 0SQL** to change the receive colour.
 - c. **3SAVE 1STEP** to change the transmit colour.
3. Press **MENU** key to select.
4. Use the **▲** and **▼** keys to pick the desired colour.
5. Press **MENU** to confirm and save.
6. Press **EXIT** to exit the menu.

To change the time the backlight stays on for your LCD, follow these steps:

Procedure 9.2. Setting backlight time-out

1. Press the **MENU** key to enter the menu.
2. Enter **6ABR** on your numeric keypad to come to backlight time out.
3. Press **MENU** key to select.
4. Use the **▲** and **▼** keys to pick the desired colour.

5. Press **MENU** to confirm and save.
6. Press **EXIT** to exit the menu.

For details see the section called “29 WT-LED - Display back-light colour, Standby” and onward in Appendix B, *Menu definitions*.

Power-on message

The power-on message can only be set via computer link, see the section called “Computer programming” for details on how to set up a link with your computer.

The following instructions assume that you've already established a link using the Baofeng software from a computer running Windows, and that the Baofeng software is already installed and running.

Procedure 9.3. Setting the power-on-message

1. Click **other** in the menu bar, a dialogue box titled "Other" should have popped up.
2. In the box titled "Power On Message", there are two text fields representing the two lines on your LCD. Enter the desired text in the fields.
3. Click **write** to write your changes to the radio.



Even though the software has eight(8) character wide text fields for the power-on message, be aware that the display on the UV-5R can only display a maximum of seven(7) characters.

Make sure that menu item 38 is set to MSG, otherwise your message wont be displayed. see Chapter 4, *Working the menu system* for details on how to navigate the menu.

Some times it takes the Baofeng software more than one try to connect to your radio. If you see a dialogue box popping up stating that you have a connection failure, close the dialogue box and click read or write again.

Chapter 10. Programming

Memory channels are an easy way to store commonly used frequencies so that they can easily be retrieved at a later date.

The Baofeng UV-5R features 128 memory channels that each can hold: Receive and transmit frequencies, transmit power, group signalling information, bandwidth, ANI/PTT-ID settings and a six character alphanumeric identifier or channel name ¹.

Manual programming

Manual programming is somewhat fiddly until you get used to it, especially when programming in duplex channels. Note that the ANI and S-CODE IDs can only be set from a computer. When programming channels it is important to remember that you can only save memory channels when working on the upper display in VFO mode.

To create a new channel, start by switching your radio to Frequency (VFO) mode using the **(VFO/MR)** key. When in Frequency (VFO) mode, select your desired receive frequency using the numerical keypad. After that, use the menu system to configure the finer details of the channel you're wanting to program to memory, such as transmit power, bandwidth, CTCSS or DCS and more.

For more information on how to use the menu system see Chapter 4, *Working the menu system* and Appendix B, *Menu definitions*. Information regarding how to set up CTCSS and DCS can be found in Chapter 8, *Selective calling*.

Simplex channels

The following steps assume that you're in Frequency (VFO) mode and that you've entered the desired frequency to store to memory.

1. Press the **(MENU)** key to enter the menu.
2. Enter **(2TXP)** **(7TDR)** on the numerical keypad to get to MEM-CH.
3. Press **(MENU)** to select.
4. Use the **(▲)** and **(▼)** keys to select a memory channel, or enter it directly on the numerical keypad.
5. Press the **(MENU)** key to confirm.
6. Press the **(EXIT)** key to exit the menu.

¹ANI/PTT-ID and channel name can only be set from a computer.

Switch to Channel (MR) mode with the **(VFO/MR)** key to test your new channel. If you would like to name your channel you will need to do that from a computer. More on that in the section called “Computer programming”.

Duplex channels

The following assumes you've set up a duplex channel in VFO mode on the upper display, as described in Chapter 11, *Repeaters*, and that you're still in VFO mode.

1. Save as you would a regular simplex channel, as described in the previous section.
2. Press the **(★SCAN)** key momentary to get into reverse mode.
3. Save that again to the same memory channel just as in step one(1).

Switch to Channel (MR) mode with the **(VFO/MR)** key to test your new channel. If you would like to name your channel you will need to do that from a computer. More on that in the section called “Computer programming”.

Computer programming

This section assumes you know where to get a hold of your software and how to install it, that you've already installed your software and that you know how to find out what port your programming cable is hooked up to.

Attaching the programming cable

Before attaching the cable, make sure your radio is turned off.

To attach the cable, uncover the accessory port behind the rubber flap on the right side of the radio body (see Figure 2.1, “Baofeng UV-5R, overview”), align the connectors and push in firmly.

Attach the USB (or DE9 in the case of standard RS-232) connector to your computer and start your programming software. You may now turn on your radio.

Baofeng software

Before starting the software, follow the steps in the section called “Attaching the programming cable”.



When you first open up the Baofeng programming software, it may default to Chinese. To change the language to English, go to the second rightmost menu. There you will find a list of available languages, select English.

When you start the Baofeng programming software you will be greeted by the Channel Information window. This is where you enter the channel information for your

memory channels. If the Channel Information window doesn't show automatically, you can bring it up by going to `Edit -> Channel Information`.

Before we start adding channels, go to `Communication` to select the port your cable is attached to. Next go to `Program -> Read from radio` and click **Read** to read in any existing channel information on the radio. This is also a good way to test the connection of the programming cable. If the read is successful the LED on your radio will start flashing red indicating that the radio is transmitting data to the computer.



The Baofeng programming software has been known to fail on connect the first try. If your connection fails, just try to read or write again.

If it continues to fail, check the connection of your cable and that you've configured your port properly in the programming software.

The Channel Information window in the Baofeng software features a simple and easy to use spreadsheet style interface. Some columns are obvious, others aren't as transparent as to what their purpose is. However, in most cases the default values tend to be the appropriate ones.

Channel Information window, column definitions

Channel	Channel number.
Band	What band, defaults to both VHF and UHF.
RX Frequency	Receive frequency.
TX Frequency	Transmit frequency. Defaults to the receive frequency.
CTCSS/DCS Dec	Receiver CTCSS or DCS. Defaults to OFF.
CTCSS/DCS Enc	Transmitter CTCSS or DCS. Defaults to OFF.
TX Power	Transmit power. Defaults to HIGH.
W/N	Wideband or Narrowband operation. Defaults to W for Wideband.
PTT-ID	Enables and sets position of PTT-ID. Defaults to OFF.
BusyLock	Busy Channel Lock-out. Defaults to OFF.
Scan_Add	Add to scanner list. When enabled the channel is included in scanning mode. Defaults to ON.
SigCode	Signal Code, group ID for the channel. Defaults to 1.
CH-Name	Channel name.

You can in theory edit any field in a row at any time, however the software seems to work best when you work from left to right.

To add a new channel, go to the row for the channel number you want to edit (you do not have to go sequentially, you can skip channel numbers if you so desire) and follow these steps:

Procedure 10.1. Adding a channel

1. Select the Band.
2. Click in the RX Frequency field next to it and enter your receive frequency.
3. Click on the TX Frequency field, and the rest of the row should fill in automatically with default values (except for CH-Name which will be kept blank).

If you're adding a duplex channel you can go ahead and enter your transmit frequency directly.

4. After that it's all just a matter of adding all the extra information and features needed for the channel based on your requirements.

When you're done you can add an optional six character Channel Name in the CH-Name field.

Repeat for all the channels you want to add.



To delete a channel, simply go to the RX Frequency field of that channel's row, erase it and click on another field. The row should now erase itself.

When you're done adding and editing channels you will want to write them to the radio. To write your information to the radio, go to Program -> Write to radio and click **Write**. On a successful write sequence the radio will start flashing green indicating that it is receiving data. When all data blocks have been sent from the computer the radio will restart itself.

Radio to radio cloning

The Baofeng UV-5R is capable of cloning between radios, meaning if you have one radio set up just the way you like it (the reference or "master" radio) and want another radio configured in exactly the same way (the "slave" radio), you just hook a cable between them and copy the information over.

Procedure 10.2. Cloning radios

1. Attach your cloning cable in much the same way you attach a programming cable, except for where you put the other end into another radio's accessory port rather than a computer.

2. Turn on the slave radio, (the radio you want to *clone to*).
3. Turn on the master radio, (the radio you want to *clone from*) while holding down the **(MON)** key.

The master will show `COPING` in the display, and if makes a successful connection to the slave it will start flashing red to indicate it's transmitting data. The slave will at that same time flash green to indicate it's receiving data.

4. When LEDs turn off, the radio's will restart and the cloning operation is completed.

Part III. How-to and setup guides.

Part three covers is a collection of how-to documents to help you set up your radio for specific working environments.

Chapter 11, *Repeaters*

Chapter 12, *Automatic Number Identification*

Chapter 13, *Application Specific Setup*

Chapter 11. Repeaters

A radio repeater is an automated transceiver in a fixed location. Usually mounted high up on hill tops or on tall buildings, but sometimes they operate within buildings for internal use. A repeater takes one signal and relays it, usually after amplifying it by orders of magnitude. This can be very handy, as this enables you to use a small low powered hand-held two-way transceiver such as the Baofeng UV-5R to reach great distances.





Whether you're a commercial (business or government) user or an amateur radio operator, chances are you'll be dealing with a repeater system sooner or later. To find out what settings to use to use your local repeater, ask your employer or someone at your local IARU member organization for details.

A common type of repeater, is the duplex repeater. In a duplex repeater system, the repeater transmits and receives simultaneously, but on different frequencies. To utilize this type of repeater, your radio have to be capable of transmitting and receiving on different frequencies on the same memory channel. How you use this kind of repeater is by setting the receive frequency of your radio to the output frequency of the repeater, and the transmit frequency of your radio to the input frequency of the repeater. Often times, the transmit frequency to use isn't explicitly stated, but rather an offset relative your receive frequency is specified. This is conveniently enough also how the Baofeng UV-5R natively handles repeater setup, by specifying offset rather than transmit frequency.

The following instructions assume that you know what transmit and receive frequencies your repeater employs, and that you're authorized to use it.

Procedure 11.1. Repeater setup

1. Set the radio to Frequency (VFO) mode with the **(VFO/MR)** key.
2. Enter the repeaters output (your receiving) frequency by either using the **(▲)** and **(▼)** keys, or by entering it directly on the numerical keypad.
3. Press the **(MENU)** key to enter the menu.
4. Enter **(2TXP)** **(6ABR)** on the numeric keypad to get to frequency offset.
5. Press **(MENU)** key to select.
6. Use the **(▲)** and **(▼)** keys and the numerical keypad to enter the specified frequency offset. See the section called "26 OFFSET - Frequency shift amount" for details.
7. Press **(MENU)** to confirm and save.
8. Enter **(2TXP)** **(5WN)** on the numeric keypad to get to offset direction.

9. Use the  and  keys to select + (positive) or - (negative) offset.
10. Press  to confirm and save.
11. Optional:
 - a. Save to memory, see the section called “Manual programming” for details.
 - b. Set up CTCSS, see the section called “CTCSS” for details.
12. Press  to exit the menu.

If everything went well, you should be able to make a test call through the repeater. If you're experiencing problems making a connection to the repeater, check your settings and/or go through the procedure again.

Certain Amateur Radio repeaters (especially in Europe) use a 1750Hz tone burst to open up the repeater. To see how this is done with the Baofeng UV-5R, see the section called “1750Hz Tone-burst”.

If you're still unable to make a connection, contact the person in charge of the radio system with your employer or your local amateur radio club, as the case may be.



If you for some reason want to listen to the repeater's input frequency instead, press  momentarily and you'll reverse your transmit and receive frequencies (reverse function not available while in Dual Watch mode).

This is indicated in the LCD on the radio with a R in the top row, next to the + and - for the offset direction.

Chapter 12. Automatic Number Identification

In dispatch environments it's common to have a system in place that will allow radios to automatically identify themselves to the dispatcher. This is known as Automatic Number Identification, or sometimes PTT-ID since the radio sends a data burst containing the ID code at the beginning or end of a transmission.

The Baofeng UV-5R uses DTMF signalling for its ANI implementation. For details on what settings to use and questions regarding system interoperability, contact the dispatch office with your employer.

Procedure 12.1. Setting ANI code

1. Attach your radio to your computer with a programming cable and open up the Baofeng programming software, see the section called “Computer programming” for details.
2. In the `Edit` menu, select `DTMF`. This will open up a window called `DTMF Encode/Decode`.
3. Go to the `Program` menu, select `Read from radio` and the `Read Data From Radio` window will open.
4. Click the `Read` button. The status LED on the radio will flash red indicating it's transmitting data.
5. Locate the box named `ANI code` and enter your personal ID number that you've been given from your dispatch office into the text field.

If you use group ID codes in addition to, or instead of personal ID codes, you can enter up to 15 of them in the list to the left in the `DTMF Encode/Decode` window. These can be assigned on channel by channel basis in the `Channel Information`, see the section called “Baofeng software” for further details.

6. Check the `Press PTT to Send` box if you want to transmit your ID before you speak, or;
check the `Release PTT to Send` box if you want to transmit your ID after you speak.
7. In the `Program` menu, select `Write to radio` and the `Write Data to Radio` window will open.
8. Click the `Write` button. The status LED on the radio will flash green indicating it's receiving data.

Unfortunately Baofeng decided to split up related functions in the programming software, so in order to enable ANI we'll have to open up yet another window and do some final configuration before the radio is ready for use.

The following assumes that you've still got the programming software running from earlier.

Procedure 12.2. Setting ANI settings

1. In the `Edit` menu, select `Optional Features`. This will open up a very crowded looking window called `Optional Features`.
2. Go to the `Program` menu, select `Read from radio` and the `Read Data From Radio` window will open.
3. Click the `Read` button. The status LED on the radio will flash red indicating it's transmitting data.
4. In the lower left corner there's a nameless box with a number of drop-down lists, including but not limited to `DTMF-ST` and `PTT_ID`.

Use the `DTMF-ST` drop-down list to select whether to send your personal ANI code (`Send ANI DTMF Side Tone`), the group code (`KB DTMF Side Tone`), or both (`DTMFST + Send ANI DTMFST`).

5. Use the `PTT-ID` drop-down list to select the position of your ANI data burst; `BOT` (Beginning of Transmit), `EOT` (End of Transmit) or `BOTH`. This is also the option that turns ANI completely off when set to `OFF`.
6. In the `Program` menu, select `Write to radio` and the `Write Data to Radio` window will open.
7. Click the `Write` button. The status LED on the radio will flash green indicating it's receiving data.

Congratulations, you've successfully set your radio up for ANI. If you're experiencing any problems, contact the dispatch office with your employer.

Chapter 13. Application Specific Setup

Commercial Radio Setup

PLMR users in the United States are mandated to move to 12.5 kHz narrowband communication in the 150-174 MHz VHF and 421-512MHz UHF bands by January 1, 2013.

Follow these instructions to set your radio to Narrowband mode:

1. Press the **(VFO/MR)** key to enter frequency mode.
2. Press the **(MENU)** key to enter the menu.
3. Enter **(5WN)** on the numerical keypad.
4. Press **(MENU)** to select.
5. Use the **(▲)** and **(▼)** keys to select between Wide and Narrow("Nar").
6. Press **(MENU)** to confirm and save
7. Press **(EXIT)** to exit the menu.

You can also switch by holding down the **(5WN)** key on the numerical keypad while in frequency mode.

If your employer has a dispatch system that requires your radio to identify via ANI, please see Chapter 12, *Automatic Number Identification* for detailed instructions on how to set that up on your radio.

To find out what other channels and features needed, please contact your employer.

Amateur Radio Setup

In contrast with Commercial radio operators, who often need very specific requirements to be compatible with a very specific radio implementation, Amateur radio operators tend to need the broadest possible settings in order to be compatible with as many systems as possible. This basically implies turning all the fancy features that you typically might need for a commercial setup off.

In a typical Amateur radio setup the following settings would be recommended:

- Set bandwidth to Wide (menu item 5).

- Turn DCS and CTCSS off (menu items 10 through 13).
- Turn ANI, DTMFST, S-CODE, PTT-ID off and PTT-LT to 0ms (menu items 15 through 17 and 19 through 20).
- Turn off Squelch Tail Elimination (STE) features (menu items 35 through 37).
- Turn roger beep (ROGER) off (menu item 39).

For further information see Appendix B, *Menu definitions* and Chapter 4, *Working the menu system*.

MilSim: Airsoft and Paintball

If you live in the USA, it is highly recommended that you and your team get yourselves GMRS licenses to use with your radios. At the time of writing the licensing fee is \$85 (per person) and the license is valid for five years. There is no exam involved and any legal resident of the US over the age of 18 can apply for a license with the FCC using form 605. Please visit <http://fcc.gov/> for more information.

The following is a list of recommended GMRS channels suitable for Airsoft games, Paintball games, or other recreational military simulations:

462.550 MHz (channel 15)
462.575 MHz (channel 16)
462.600 MHz (channel 17)
462.625 MHz (channel 18)
462.725 MHz (channel 22)



Channel numbers reflect a convention used by Motorola, actual mapping of frequency to channel number may vary between manufacturers.

For those not living in the USA, please contact your local regulatory body in charge of the radio spectrum to see what your options are.



You may be tempted to use FRS (in the USA) or PMR446 (in Europe) frequencies while playing. Do note however that there are restrictions on both of these bands that make this transceiver illegal for use.

Not only do you need a radio with a maximum of 500mW output power (the Baofeng UV-5R provides at minimum twice that), you also aren't allowed to use a radio with a detachable antenna or a radio that can be used outside of the FRS or PMR446 bands.

In the US there is one exception to that rule, and that is FRS+GMRS combo units, however they are still restricted to 500mW output power on the FRS frequencies, and they still have to be manufactured with a fixed integral antenna.

Appendix A. Troubleshooting

Symptom	Possible cause	solution
The radio doesn't start.	The battery is too low. The battery isn't correctly installed.	Change or recharge the battery. Remove the battery and re-install it.
The battery dies quickly.	The battery is dead. The battery isn't fully charged.	Purchase a new battery. Recharge the battery.
The LED indicates reception, but the speaker is silent.	Volume is too low. CTCSS or DCS enabled.	Turn up the volume. Change your CTCSS or DCS to match those you're trying to communicate with. Or turn CTCSS or DCS off.
Others can't hear my transmission.	Their CTCSS or DCS settings doesn't match yours. You're too far apart.	Change your CTCSS or DCS settings to match your peers. Move in closer.
The radio transmits without touching the PTT.	The VOX is enabled. VOX sensitivity is too high.	Turn VOX off. Turn down VOX sensitivity.

Appendix B. Menu definitions

See Chapter 4, *Working the menu system* for more info about using the menu-system.



0 SQL - Squelch Level

Selects the squelch noise threshold.

Values	Notes	Default value
0-9		3

Setting the squelch to 0 will open up the squelch entirely.

1 STEP - Frequency Step

Selects the step in frequency when using the  and  keys. This is also the interval the scanner will run at.

Key	Values (kHz)	Notes	Default value
0	2.5K		25.0K
1	5.0K		
2	6.25K		
3	10.0K		
4	12.5K		
5	25.0K		

This does only affect the radio when in Frequency (VFO) Mode.

2 TXP - Transmit Power

Transmit power is only settable in Frequency(VFO) Mode. In Memory(MR) Mode transmit power will be set to the level programmed in memory for any given channel.

Key	Values	Notes	Default value
0	HIGH	4W	HIGH
1	Low	1W	

3 SAVE - Battery Save

Sampling ratio of the Receiver to acknowledge a signal

Values	Notes	Default value
1 - 4		3
OFF		

4 VOX - Voice Operated TX

Adjusts the sensitivity of the VOX feature, if enabled.

Values	Notes	Default value
1 - 10		OFF
OFF		

The lower the setting, the louder your voice have to be in order to engage the transmitter.

5 WN - Wideband / Narrowband

Sets maximum band deviation.

Key	Values	Notes	Default value
0	WIDE	5kHz	WIDE
1	NARR	2.5kHz	

In the USA, FCC part 90 radios are mandated to switch over to Narrowband communication by January 1st 2013. Meaning all commercial users. This does not affect Amateur Radio operators.

6 ABR - Display Illumination Time

Time-out for the LCD back-light.

Values (seconds)	Notes	Default value
1 - 5		5
OFF		

7 TDR - Dual Watch

When enabled it allows you to monitor two frequencies simultaneously.

Key	Values	Notes	Default value
1	ON		OFF
0	OFF		

It should be noted that this radio does not possess a dual VFO, meaning that the Dual Watch feature is a time sharing operation. Your radio will flip-flop between A and B channels at a fixed rate. This will not allow you to receive two frequencies in parallel.

8 BEEP - Keypad Beep

When enabled your radio will emit an audible tone at every key press.

Key	Values	Notes	Default value
1	ON		ON
0	OFF		

9 TOT - Transmission Time-out-Timer

Transmission times out after set time. Radio will alert you when your time is up.

Values (seconds)	Notes	Default value
15 - 600	Increments of 15 seconds	60

To use the numeric keypad for input, use the following formula: $(T-15)/15 = X$, where T is the time in seconds that you want and X is a two digit code on your keypad.

Example: To get 300 seconds, take $(300-15)/15$ to get 19

10 R-DCS - Receiver DCS

Digital-Coded Squelch(DCS) will block out any signal that isn't sent with a matching DCS code.

Values	Notes	Default value
D023N - D754I		OFF
OFF		

See Table C.1, "DCS Codes" for a complete reference of DCS codes and their corresponding numerical value. Remember to input any leading zeros when using the numerical keypad. To set it to off, enter code 000.

11 R-CTCS - Receiver CTCSS

Continuous Tone-Coded Squelch System(CTCSS) will block out any signal that isn't sent with a matching CTCSS sub-tone.

Values (Hz)	Notes	Default value
67.0 - 254.1		OFF
OFF		

See Table C.2, “CTCSS Frequencies” for a complete reference of CTCSS sub tones. To enter a CTCSS tone on the numerical keypad, enter its frequency directly rather than the numerical code. Remember to input any leading zeros when using the numerical keypad. To set it to off, enter code 000.

12 T-DCS - Transmitter DCS

Sets the Digital-Coded Squelch(DCS) code for the transmitter.

Values	Notes	Default value
D023N - D754I		OFF
OFF		

See Table C.1, “DCS Codes” for a complete reference of DCS codes and their corresponding numerical value. Remember to input any leading zeros when using the numerical keypad. To set it to off, enter code 000.

13 T-CTCS - Transmitter CTCSS

Sets the Continuous Tone-Coded Squelch System(CTCSS) sub-tone for the transmitter.

Values	Notes	Default value
67.0 - 254.1		OFF
OFF		

See Table C.2, “CTCSS Frequencies” for a complete reference of CTCSS sub tones. To enter a CTCSS tone on the numerical keypad, enter its frequency directly rather than the numerical code. Remember to input any leading zeros when using the numerical keypad. To set it to off, enter code 000.

14 VOICE - Voice Prompt

When enabled your radio will "talk back" to you, meaning audible confirmation when pressing keys and working the menu system.

Key	Values	Notes	Default value
1	ENG	English	ENG

Key	Values	Notes	Default value
2	CHI	Chinese	
0	OFF		

In some versions of the firmware your options may be restricted to ON and OFF.

15 ANI-ID - Automatic Number ID

This can only be set via Computer Linked programming.

Values	Notes	Default value
		80808

16 DTMFST - DTMF tone of transmit code

Selects if you should send your S-CODE(DT) or ANI code with the PTT-ID.

Key	Values	Notes	Default value
1	DT-ST	S-CODE only	DT+ANI
2	ANI code only ANI-ST		
3	DT+ANI	Both	
0	OFF		

You cannot set DTMFST while in channel/memory mode.

17 S-CODE - Signal Code

S-CODE sets your transceiver to one of the fifteen(15) group ID codes. The actual ID codes are only settable from a computer.

Values	Notes	Default value
1 - 15		1

You cannot set S-CODE while in channel/memory mode.

18 SC-REV - Scanner Resume Method

Sets the behaviour of the scanner upon finding active frequencies.

Key	Values	Notes	Default value
0	TO	Time Operation	TO
1	CO	Carrier Operation	
2	SE	Search Operation	

- Time Operation: The scanner will resume after a pre set time.
- Carrier Operation: The scanner will resume once the signal disappears.
- Search Operation: The scanner holds on the frequency with detected activity.

19 PTT-ID - When to send the PTT-ID

Sets when to send the PTT-ID (ANI and/or S-CODE) code(s).

Key	Values	Notes	Default value
1	BOT	Beginning Of Transmit	OFF
2	EOT	End Of Transmit	
3	BOTH	Both BOT and EOT	
0	OFF		

You cannot set PTT-ID while in channel/memory mode.

20 PTT-LT - Signal code sending delay.

Delay before sending the PTT-ID.

Values (ms)	Notes	Default value
0 - 30		5

21 MDF-A - Channel Mode A Display

Sets the display mode for the upper display.

Key	Values	Notes	Default value
0	CH	Channel number	FREQ
1	NAME	Channel name	
2	FREQ	Frequency	

Channel name can only be set via Computer.

22 MDF-B - Channel Mode B Display

Sets the display mode for the lower display.

Key	Values	Notes	Default value
0	CH	Channel number	FREQ
1	NAME	Channel name	
2	FREQ	Frequency	

Channel name can only be set via Computer.

23 BCL - Busy Channel Lock-out

If enabled your radio will prevent you from transmitting on active frequencies.

Key	Values	Notes	Default value
1	ON		OFF
0	OFF		

24 AUTOLK - Automatic Keypad Lock

If enabled keypad will automatically lock after eight(8) seconds of inactivity.

Key	Values	Notes	Default value
1	ON		OFF
0	OFF		

25 SFT-D - Frequency Shift Direction

Sets the direction of the transmit offset relative receive frequency.

Key	Values	Notes	Default value
1	+	TX frequency = RX + OFFSET	OFF
2	-	TX frequency = RX - OFFSET	
0	OFF		

26 OFFSET - Frequency shift amount

Sets the amount of offset on the transmit frequency relative the receive frequency.

Values (MHz)	Notes	Default value
00.000 - 69.990		00.000

To input an offset frequency with the numeric keypad, enter the frequency in 10 megahertz with leading zeroes. For a 2MHz shift, enter **0SQL** **2TXP**. For a 600kHz shift, enter **0SQL** **0SQL** **6ABR**.

Use the **▲** and **▼** keys to set offsets below 100kHz.

27 MEM-CH - Store a Memory Channel

Stores current settings in memory to the specified channel number.

Values	Notes	Default value
000 - 127		000

28 DEL-CH - Delete a memory channel

Deletes a memory channel at the specified channel number.

Values	Notes	Default value
0 - 127		000

29 WT-LED - Display back-light colour, Standby

Sets the back-light colour in standby.

Key	Values	Notes	Default value
1	BLUE		PURPLE
2	ORANGE		
3	PURPLE		
0	OFF		

30 RX-LED - Display back-light colour, Receive

Sets the back-light colour while receiving a signal.

Key	Values	Notes	Default value
1	BLUE		BLUE
2	ORANGE		
3	PURPLE		
0	OFF		

31 TX-LED - Display back-light colour, Transmit

Sets the back-light colour while transmitting a signal.

Key	Values	Notes	Default value
1	BLUE		ORANGE
2	ORANGE		
3	PURPLE		
0	OFF		

32 AL-MOD - Alarm Mode

Key	Values	Notes	Default value
0	SITE	Cycling tone over the air	SITE
1	TONE	Radio speaker only	
2	CODE	Transmit 5s tone followed by Morse	

33 BAND - Band Selection

Sets the current operating band.

Key	Values	Notes	Default value
0	VHF		VHF
1	UHF		

34 TDR-AB - Transmit selection while in Dual Watch mode

If enabled, this will force the radio to transmit on the selected frequency when in Dual Watch mode.

Key	Values	Notes	Default value
1	A	Upper display	OFF
2	B	Lower display	
0	OFF		

35 STE - Squelch Tail Elimination

Key	Values	Notes	Default value
1	ON		ON
0	OFF		

36 RP-STE - Squelch Tail Elimination through a repeater

Values	Notes	Default value
1 - 10		5
OFF		

37 RPT-RL - Delay the squelch tail of repeater

Values	Notes	Default value
1 - 10		OFF

Values	Notes	Default value
OFF		

38 PONMGS - Power On Message

When enabled it displays a 2 line message on the display. Message can only be set via computer.

Key	Values	Notes	Default value
0	FULL	Flash entire LCD	MSG
1	MSG	Displays a 2 line welcome message	

39 ROGER - Roger Beep

Transmits an audible tone after you release the PTT.

Key	Values	Notes	Default value
1	ON		OFF
0	OFF		

40 RESET - Restore defaults

Resets the radio to factory defaults, with some exceptions.

Key	Values	Notes	Default value
0	VFO	VFO settings only	ALL
1	ALL	Total reset*	

* RESET>ALL resets everything with the exception of:

The Power On Message

The VIP software band limits

On some firmware it may reset language to Chinese

Appendix C. Technical specifications

General

General specifications

Specification	Value
Frequency Range (MHz)	65-108 (Rx only) 136-174 (Rx/Tx) 400-480 (Rx/Tx)
Memory channels	128
Frequency stability	2.5ppm
Frequency step (kHz)	2.5 / 5 / 6.25 / 10 / 12.5 / 25
Antenna impedance	50 Ohm
Operating temperature	-20°C to +60°C
Supply voltage	7.4
Consumption	≤ 75mA (standby) 380mA (reception) ≤ 1.4A (transmission)
Mode of operation	Simplex or semi-duplex
Duty cycle	03 / 03 / 54 min. (Rx / Tx / Standby)
Dimensions (mm)	58 x 110 x 32
Weight (g)	214

Transmitter

Transmitter specifications

Specification	Value
RF power (W)	4 (UHF high) 4 (VHF high) 1 (UHF low) 1 (VHF low)
Type of modulation	FM
Emission class	16K#F3E (wideband) 11K#F3E (narrowband)
Maximum deviation (kHz)	≤ ± 5.0 (wideband) ≤ ± 2.5 (narrowband)
Spurious emissions (dB)	<-60dB

Receiver

Receiver specifications

Specification	Value
Receiver sensitivity	0.2 μ V (at 12dB <i>SINAD</i>)
Intermodulation	60dB
Audio Output	1000mW
Adjacent channel selectivity	65/60dB

DCS table

Table C.1. DCS Codes

Number	Code	Number	Code	Number	Code
001	D023N	002	D025N	003	D026N
004	D031N	005	D032N	006	D036N
007	D043N	008	D047N	009	D051N
010	D053N	011	D054N	012	D065N
013	D071N	014	D072N	015	D073N
016	D074N	017	D114N	018	D115N
019	D116N	020	D122N	021	D125N
022	D131N	023	D132N	024	D134N
025	D143N	026	D145N	027	D152N
028	D155N	029	D156N	030	D162N
031	D165N	032	D172N	033	D174N
034	D205N	035	D212N	036	D223N
037	D225N	038	D226N	039	D243N
040	D244N	041	D245N	042	D246N
043	D251N	044	D252N	045	D255N
046	D261N	047	D263N	048	D265N
049	D266N	050	D271N	051	D274N
052	D306N	053	D311N	054	D315N
055	D325N	056	D331N	057	D332N
058	D343N	059	D346N	060	D351N
061	D356N	062	D364N	063	D365N
064	D371N	065	D411N	066	D412N

Number	Code	Number	Code	Number	Code
067	D413N	068	D423N	069	D431N
070	D432N	071	D445N	072	D446N
073	D452N	074	D454N	075	D455N
076	D462N	077	D464N	078	D465N
079	D466N	080	D503N	081	D506N
082	D516N	083	D523N	084	D526N
085	D532N	086	D546N	087	D565N
088	D606N	089	D612N	090	D624N
091	D627N	092	D631N	093	D632N
094	D645N	095	D654N	096	D662N
097	D664N	098	D703N	099	D718N
100	D723N	101	D731N	102	D732N
103	D734N	104	D743N	105	D754N

CTCSS table

Table C.2. CTCSS Frequencies

Number	Frequency	Number	Frequency
01	67.0	02	69.3
03	71.9	04	74.4
05	77.0	06	79.7
07	82.5	08	85.4
09	88.5	10	91.5
11	94.8	12	97.4
13	100.0	14	103.5
15	107.2	16	110.9
17	114.8	18	118.8
19	123	20	127.3
21	131.8	22	136.5
23	141.3	24	146.2
25	151.4	26	156.7
27	159.8	28	162.2
29	165.5	30	167.9

Number	Frequency	Number	Frequency
31	171.3	32	173.8
33	177.8	34	179.9
35	183.5	36	186.2
37	189.9	38	192.8
39	196.6	40	199.5
41	203.5	42	206.5
43	210.7	44	218.1
45	225.7	46	229.1
47	233.6	48	241.8
49	250.3	50	254.1

Colophon

All linework drawings were recreated in Inkscape [<http://inkscape.org/>] using the original Baofeng manual artwork as reference.

