

ESCORT iX

Long Range Protection + Bluetooth® Connectivity



iX

Intelligent Long Range
Radar Laser Detector

Designed in the USA

ESCORT Inc.
5440 West Chester Road
West Chester OH 45069

800.433.3487
EscortRadar.com

ESCORT Live Compatible



©2016 ESCORT INC. ESCORT®, ESCORT iX®, ESCORT Live™, DEFENDER®, TrueLock™, SpecDisplay™, ExpertMeter™, SmartMute™, IVT Filter™, and EZ Mag Mount™ ARE TRADEMARKS OF ESCORT INC.

APPLE AND THE APPLE LOGO ARE TRADEMARKS OF APPLE INC., REGISTERED IN THE U.S. AND OTHER COUNTRIES. APP STORE IS A SERVICE MARK OF APPLE INC.

ANDROID, GOOGLE PLAY, AND THE GOOGLE PLAY LOGO ARE TRADEMARKS OF GOOGLE INC. THE BLUETOOTH® WORD MARK AND LOGOS ARE REGISTERED TRADEMARKS OWNED BY BLUETOOTH SIG, INC. AND ANY USE OF SUCH MARKS BY ESCORT IS UNDER LICENSE.

FCC NOTE:
Modifications not expressly approved by the manufacturer could void the user's FCC granted authority to operate the equipment.

FCC ID:QKLM4IX. CONTAINS FCC ID:QKLB2.
This device complies with part 15 of the FCC rules. Operation is subject to the following two conditions: (1) This device may not cause harmful interference, and (2) this device must accept any interference received including interference that may cause undesired operation.



GPS Intelligence Rejects False Alerts



ESCORT Live App Provides
Crowd Sourced Alerts



Excellent Radar/Laser Detection Range

Owner's Manual

Congratulations



ESCORT iX

Congratulations!

You've just purchased the ESCORT iX with long-range radar-laser performance, GPS-based intelligence and instant Bluetooth® connectivity to the award-winning ESCORT Live speed trap app.

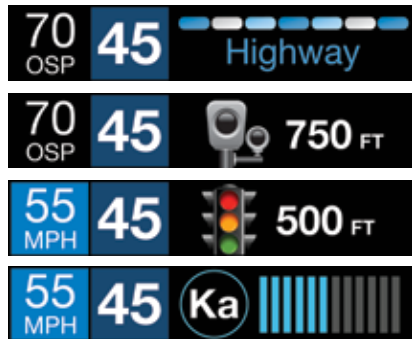

ESCORT iX features a multi-color OLED display. Brilliant graphics illuminate intuitive icons that identify the type of threat at a glance.

ESCORT iX Features

- The ESCORT iX delivers long-range warning on all radar bands including X, K, Superwide Ka.
- ESCORT iX's GPS location-based intelligence automatically locks out false alerts and allows you to mark locations for future reference.
- ESCORT iX gives you access to ESCORT's DEFENDER Database, which warns you of verified speed traps, speed cameras, and red light cameras.
- The ESCORT iX with built in Bluetooth® technology gives you access to ESCORT's award winning app, ESCORT Live. Our exclusive real-time ticket-protection, the network which warns you of upcoming alerts received and reported by other users in the area, and gives you access to local speed limit data for over-speed alerts.



Live Ready!



Table of Contents

Getting Started	4	• Alert Tones	9
• Registration	4	• Standard	9
• Downloading ESCORT Live!	4	• Mild	9
• Pairing Your Smartphone	4	• Cruise Alert	9
• Installation – What's Included	5	• Voice Alerts	9
• Installation – Mounting	5	• Over-Speed Alert	9
Controls & Features	6	• Signal-Strength Meter	9-10
• Using ESCORT iX	6	• Standard	9
• Using SmartCord USB	6	• SpecDisplay	9
Settings & Preferences	7-13	• ExpertMeter	10
• AutoPower	7	• Simple	10
• Volume	7	• Clearing the Database	11
• Mute	7	• Serial Number & Software Version	11
• AutoMute	7	• How To Use Preferences	11
• SmartMute	7	• Settings & Preferences – Overview	12-13
• User Mode	7	• Restore Detector Settings	13
• Advanced	7	Understanding Your Detector	14-11
• Novice	7	• Interpreting Alerts	14
• Display Color	7	• How Radar Works	15
• Display Brightness	7	• How Pop Works	15
• Speed Display	7	• How Laser Works	15
• Radar Sensitivity	7	• How TSR Works	16
• Highway	8	• How Red Light Cameras Work	16
• Auto	8	• How Speed Cameras Work	16
• Auto No X	8	• How GPS Works	17
• Auto Lo K	8	Software Updates	17
• TrueLock/Locking Out False Alerts	8	Troubleshooting	18
• AutoLearn	8	Service	19
• Marking Locations	8-9	Parts & Accessories	19
• Over-Speed Alert	9	Warranty	19

Registration



Before downloading ESCORT Live you must first register your ESCORT iX. Be sure to have your ESCORT iX nearby, as you will need the serial number.

- 1 Visit www.EscortRadar.com and click Product Registration.
- 2 Click the "Registration for all devices" link.
- 3 Follow the onscreen instructions to register your device.

Be sure to write down the username and password you create, as you will need this information to access and download ESCORT Live. (You will also receive an email with this information, once you have registered your device.)

ESCORT Live

For iPhone:

- 1 Ensure ESCORT iX power is ON 
- 2 Open the App Store on your iPhone and search for **ESCORT Live Radar**.
- 3 Follow the onscreen instructions to download **ESCORT Live Radar** and then open the app.
- 4 When prompted, enter the username and password you created when registering your product at EscortRadar.com.
- 5 Press the Settings button  then select **Devices**. 
- 6 You should see **iX** listed with Not Connected underneath. Press the **iX** device entry and when prompted select Pair.
- 7 The Bluetooth icon on the ESCORT iX display will appear to confirm that it is paired to your iPhone.

For Android based smartphones:

- 1 Ensure ESCORT iX power is ON.
- 2 On your smartphone go to Bluetooth® Settings and make sure that Bluetooth® is ON.
- 3 Press Scan for devices and wait for the device list to populate, **iX** should appear under Available devices.
- 4 Press the **iX** device entry.
- 5 The Bluetooth icon on the ESCORT iX display will appear to confirm that it is paired to your smartphone. 
- 6 Open Google Play on your smartphone and search for **Escort Live Radar**.
- 7 Follow the onscreen instructions to download **Escort Live Radar** and then open the app.
- 8 When prompted, enter the username and password you created when registering your product at EscortRadar.com.
- 9 Open the app, walk through the tutorial, and you're ready to hit the road!

Installation

ESCORT iX comes with our latest EZ Mag Mount™. Simply tilt the display end of the detector up and slide it onto the mounting bracket. The magnetic mount holds the detector in place. To remove the detector from the mount, simply lift the display end of the detector and the detector releases from the mount.

What's Included

- ESCORT iX Radar/laser detector
- EZ Mag Mount™ windshield mount
- SmartCord USB power adapter
- Quick Reference Guide
- Zippered Travel Case

Mounting Tips

- Place on center of windshield between driver and passenger.
- Ensure clear view of road ahead and sky above.
- Avoid windshield wipers and heavily tinted areas.

To mount the detector in your vehicle

- 1 Remove paper backing from EZ Mag Mount™ StickyCup.
- 2 Ensure the locking clamp is open.
- 3 Firmly press EZ Mag Mount™ StickyCup onto windshield and close the locking clamp to secure.
- 4 To adjust view, loosen thumb wheel and adjust angle of mounting bracket. Tighten thumb wheel to secure.
- 5 Tilt the display end of the detector slightly upward and engage with the flanged edge of the mounting bracket. The EZ Mag Mount™ magnet holds the detector in place.
- 6 To remove the detector, simply lift the display end of the detector upward. The ESCORT iX will release from the mount.
- 7 To remove mount from windshield, release locking clamp and pull tab on top of StickyCup.

EZ Mag Mount™ Care Instructions:

Should the EZ Mag Mount™ StickyCup accumulate debris and lose its stickiness, simply rinse under warm water, gently wipe off debris and allow to air dry.

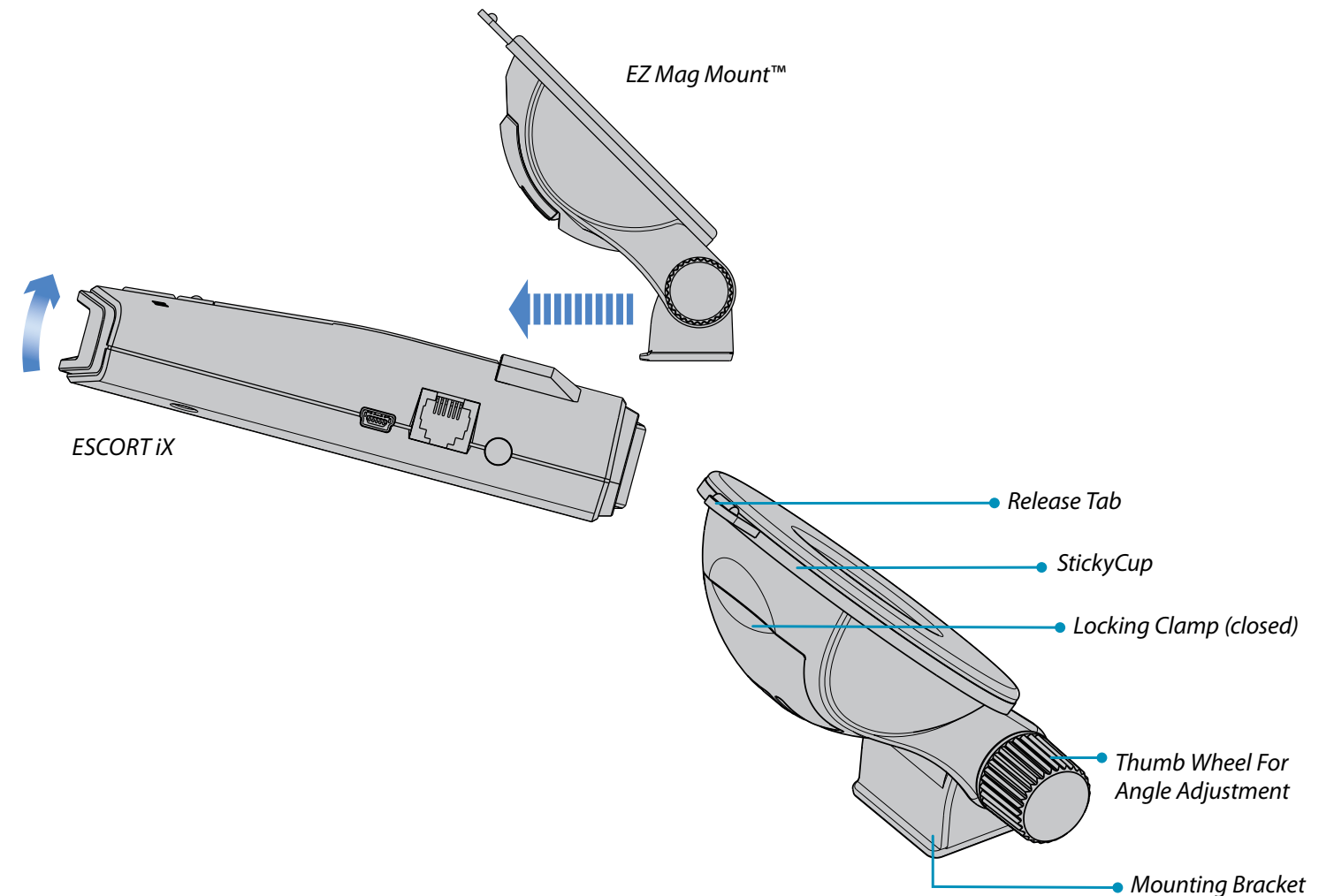

Using ESCORT iX

- 1 Plug small end of SmartCord USB into modular jack on ESCORT iX and large end of SmartCord USB into your car's lighter/accessory socket.
- 2 ESCORT iX should power on automatically. If not, press the device's power button. 

NOTE: You can easily access and customize all of your Settings and Preferences by pressing and holding the MRK and SEN buttons. See Settings & Preferences for details.

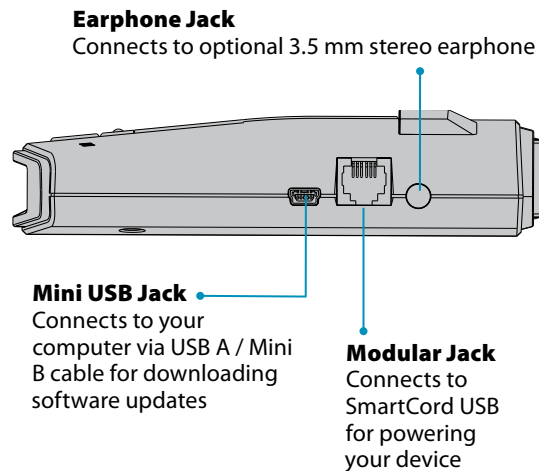

Using SmartCord USB

- **Mute Button:**
 - Press to mute the audio for a specific alert.
 - Press three times to lock out a false alert.
 - Press twice while receiving a locked-out alert to unlock.
 - When connected to ESCORT Live press and hold mute button on unit or cord to manually report to other users a verified X or K-band alert, or a police officer observing traffic.
- **Alert Light:** Blinks red when receiving a radar or laser alert.
- **Power Light:** Lights green when receiving power.
- **USB Charging Port:** Charge smartphones, tablets and other USB-charged Devices.



SmartCord USB Adapter
Connects to lighter/accessory socket

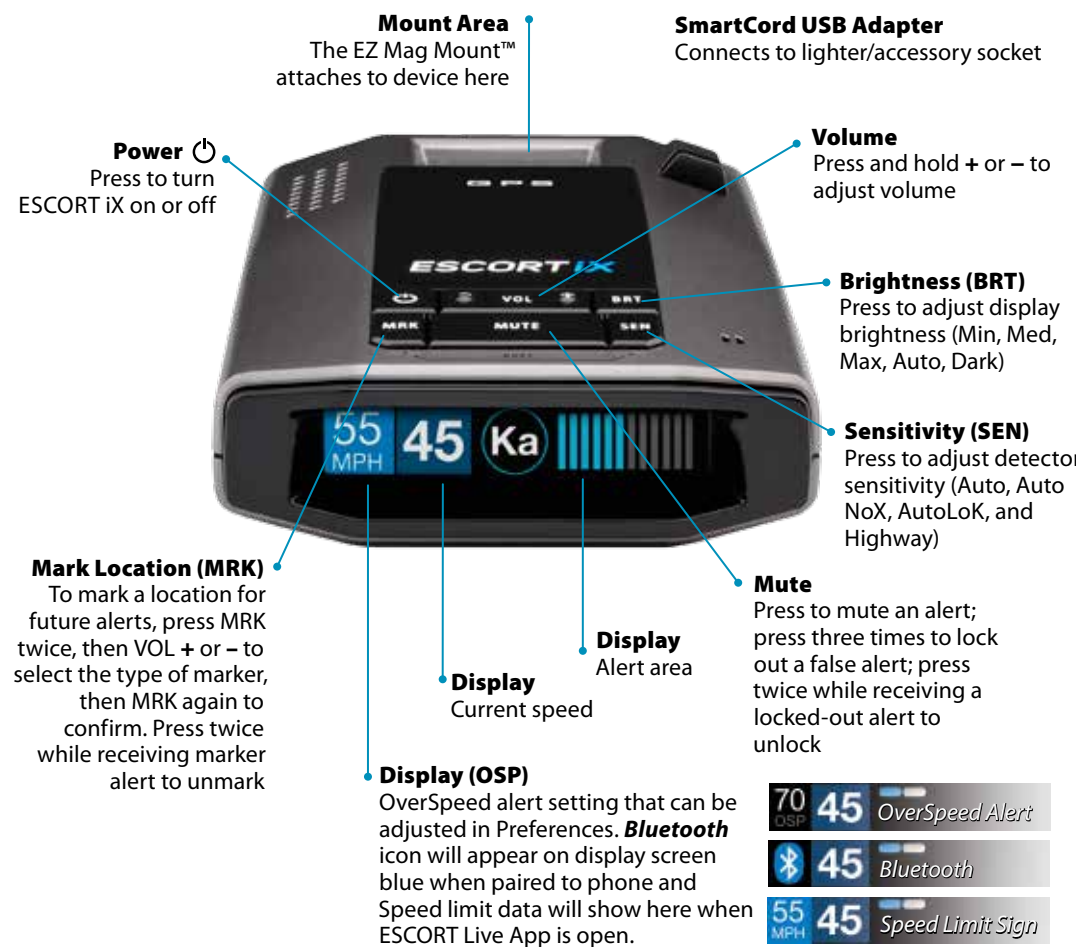

AutoPower

This feature automatically turns off ESCORT iX after a set period of time to save unnecessary drain on your battery. This is especially useful if your vehicle has a constant-power ignition. To turn ESCORT iX on again you must press the power button. See the Settings & Preferences section for details on how to customize the AutoPower feature.

NOTE: If AutoPower is on, to save screen life the display screen goes blank after 30 minutes without moving. Display screen will turn on automatically after you reach 10MPH.

Volume

To adjust ESCORT iX to your preferred audio level for alerts, simply press and hold + or -. The audio will increase/decrease while it is depressed. Once you reach the desired audio level, simply release the button. ESCORT iX will retain this setting in its memory, even if the system is turned off.

Mute

The MUTE button allows you to silence the audio during an alert. Simply press the button during the alert. Once the radar encounter has passed, the mute will disengage, and the audio will return to your pre-set level. You can also silence an alert by pressing the SmartCord USB MUTE button.

AutoMute

Your ESCORT iX also includes ESCORT's patented AutoMute feature. Once ESCORT iX alerts you to a radar encounter at your selected volume level, it automatically reduces the volume to your desired level. This keeps you informed without the annoyance of a continuous full-volume alert. If you prefer, you can turn the AutoMute feature off. See the Settings & Preferences section for details.

SmartMute

If AutoMute has already reduced the volume for one alert and a higher-priority band is detected, ESCORT iX will sound an alert at your set volume for the second band before adjusting the volume back down to the AutoMute level.

User Mode

ESCORT iX offers two unique user modes:

Advanced

In this mode, you can access and customize all of ESCORT iX's settings and preferences.

Novice

In this mode, you can access and customize units (English or metric) and display color only. All other preferences are set to the factory defaults. To view all settings and preferences, you must switch back to Advanced mode.

Display Color

Your detector screen can be displayed with blue, green, red or amber accents to match the dashboard lighting of various vehicles. See the Settings & Preferences section for details on how to change the display color.



Display Brightness

ESCORT iX's display brightness is automatically adjusted to suit ambient lighting conditions in your car. If you prefer, you can press the BRT button to set a fixed brightness level:

- Auto** Automatically adjusts brightness (factory setting)
- Dark** Dark mode
- Minimum** Minimum brightness
- Medium** Medium brightness
- Maximum** Maximum brightness

NOTE: If you select Dark mode, the display will not provide any indication that it is on. Therefore, only audible alerts will notify you of detected signals.

Speed Display

ESCORT iX displays your current speed just to the right of the Over-Speed Alert setting (or posted speed limit for your current location, if connected to ESCORT Live). If you prefer, you can turn off the speed display feature (see Settings & Preferences section for details). If speed display is OFF, ESCORT iX will simply display your battery voltage in this location

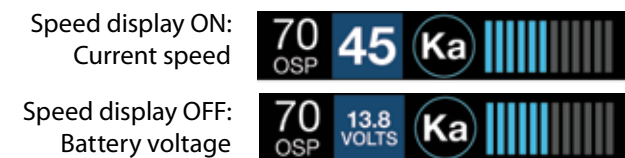

Radar Sensitivity

The SEN button allows you to select your preferred radar sensitivity: Highway, Auto, AutoNoX, or AutoLoK. In general, ESCORT recommends Auto for everyday driving.

Highway

In this setting, ESCORT iX will detect all radar signals on all bands at maximum range.

Auto

In this setting, ESCORT iX will continuously analyze all incoming signals and intelligently adjust the sensitivity circuits, providing long-range warning with minimal false alarms.

Auto No X

Auto No X works the same as Auto mode; however, X band is completely turned off.

Auto Lo K

Auto Lo K works the same as Auto mode; however K band sensitivity is lowered.

WARNING: Do not use ESCORT iX in Auto No X unless you are absolutely certain that there are no traffic radar guns using X band in your area.

TrueLock/Locking Out False Alerts

ESCORT iX is equipped with a TrueLock GPS Filter to lock out and store in its memory false alerts. To lock out a false alert (X band, K band or laser only), press the MUTE button on the detector or the SmartCord USB three times during an alert. Pressing the first time will silence the audio. Pressing a second time will generate a prompt on the display that will read "Lockout?" Press a third time to confirm you want to lock this signal out by location and frequency. A "Stored" message will be displayed. Once a signal has been stored, ESCORT iX will reject the signal the next time you approach this area and will display the locked-out alert.



To unlock a signal that has already been stored, simply press and hold the detector or SmartCord USB MUTE button while receiving the locked out alert. The display will read "Unlock?" Press the detector or SmartCord USB MUTE button again to unlock it from memory. The display will then read "Unlocked" to confirm your action.

For details on how to turn the GPS Filter off, refer to the Settings & Preferences section.

NOTE: When the GPS Filter is set to OFF, you do not have access to ESCORT iX's other GPS-enabled features (e.g., Defender Database alerts, marking locations, etc.).

AutoLearn

The AutoLearn feature analyzes (over time) the source of radar signals by location and frequency. This allows ESCORT iX to determine if a signal is a real threat or a false one. If it determines that the signal is an automatic door opener, motion sensor, etc., it automatically locks out this source at this particular location. A "Stored" message will appear on the display when a signal has been automatically locked out. If you prefer, you can turn the AutoLearn feature off. See the Settings & Preferences section for details.

NOTE: AutoLearn typically needs to encounter the exact frequency in the same location approximately three times to lock it out. Since some door openers are turned on and off routinely, some variations may occur. When AutoLearn is on, ESCORT iX will also unlearn signals to protect you from locking out real threats. If a particular signal is no longer present at a location that was previously locked out, ESCORT iX will unlock that signal.

Marking Locations

The MRK button allows you to mark a specific location and label it for future reference. Once marked, ESCORT iX will provide an alert when you reach this area again.

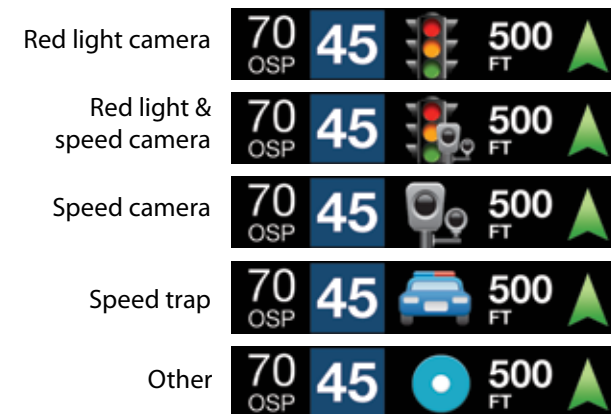

ESCORT iX gives an advanced warning of upcoming markers at the following distances:

- **Red light cameras:** 250 ft or 10 seconds
- **Red light & speed cameras:** 250 ft or 10 seconds
- **Speed cameras:** 500 ft when traveling below 55 mph; 1,000 ft when traveling above 55 mph
- **Speed traps:** 0.3 mi or approximately 1,584 ft
- **Other:** 500 ft when traveling below 55 mph; 1,000 ft when traveling above 55 mph

To mark a location, press the MRK button. The display will read "Mark?" Press MRK again to bring up a menu of markers to choose from. Press + or - to scroll through the markers, then press MRK to select the marker you wish to use at this location. The display will read "Marked!"

NOTE: When a location is marked the first time, you must travel at least 1 mile away from that location to receive an alert when you return to the area.

To unmark a location, touch the MRK button when you are receiving a marked-location alert. The display will read "Unmark?" Touch the MRK button again to confirm. The display will read "Unmarked!" To customize the types of markers you want to be able to set and receive, see the Settings & Preferences section.

Over-Speed Alert

With ESCORT iX, you can set the Over-Speed Alert to notify you when you are traveling over a specified speed (factory default is 70 mph; see Settings & Preferences for details). When you travel above the speed threshold you have set, the background display for your current speed will turn red to alert you that you have exceeded the specified speed.

Alert Tones

Standard

The factory default for alert tones is the ESCORT Standard mode, in which ESCORT iX uses a Geiger counter-type sound to indicate the signal strength and type of radar signal being encountered. When you encounter radar, a distinct audible alert will sound and will increase as the signal gets stronger. This allows you to judge the distance from the signal source without taking your eyes off of the road. Each band has a distinct tone for easy identification:

- X band = beep tone
- K band = brap tone
- Ka band = double-brap tone
- Laser = solid brap tone
- Pop = solid brap tone

Mild

Mild mode offers softer, simpler alert tones that are less obtrusive to the driving experience:

- X band, K band, Ka band and Pop = Doorbell chime
- Low signal strength = Double chime
- High signal strength = Triple chime
- If alert remains in area more than 15 seconds = Single chime (as a reminder)
- Laser = Solid brap tone

Since laser signals are a possible threat no matter how weak, ESCORT iX alerts you to all laser signals with a full laser alert. See the Settings & Preferences section for details on switching your alert tones.

Cruise Alert

For all alerts received while traveling below the specified speed, ESCORT iX will sound a simple double-beep alert (factory default is 20 mpg; see Settings & Preferences for details).

Voice Alerts

ESCORT iX provides digital voice announcements for alerts and selection feedback. If you prefer, you can turn off the voice feature. See the Settings & Preferences section for details.

Signal-Strength Meter

ESCORT iX offers four different settings for displaying alerts:



Standard

The Standard option provides information on a single radar signal. When ESCORT iX detects radar, it displays the band of the radar (X, K or Ka) and a bar graph of the signal's strength. When laser is detected, the display will simply read "Laser." If there are multiple signals present, ESCORT iX will determine which one is the most important threat to display.



SpecDisplay

The SpecDisplay option is an advanced display for experienced detector users. In this mode, it will display the actual numeric radar frequency being received. Even long-time detector users will require some time to get familiar with this new level of information about detected signals. To use SpecDisplay instead of the Standard bar graph meter, you must select it (Spec) in Preferences.



ExpertMeter

ESCORT's exclusive ExpertMeter option is also designed for the advanced detector user. In this mode, ESCORT iX simultaneously tracks up to four radar signals. It shows each band along with a bar graph of its signal strength. In the image above, a Ka band, K band and two X bands are being detected with the greyed out X band being a locked out false. ExpertMeter can help you spot a change in your normal driving environment (e.g., a traffic radar unit being operated in an area where there are normally other signals present).



Simple

In this mode, Simple messages replace actual bands and signal strengths or frequencies. "Caution" is used when an alert is received while you are traveling below your current Cruise Alert setting (or posted speed limit for current location, when connected to ESCORT Live). "Slow Down" is displayed when an alert is received while you are traveling above the current Cruise Alert setting (or posted speed limit for current location, when connected to ESCORT Live).

NOTE: ESCORT iX's selectable bands feature allows you to customize which bands are monitored. For details on modifying your band detection, see the Settings & Preferences section. For details on the various radar/laser bands and how they work, see the Understanding Your Detector section.

Clearing the Database

At some point, you may wish to clear some of the data in ESCORT iX's database. This may include any of the following: Defender Database data, marked locations or locked-out locations. For details on how to clear the database, see the Settings & Preferences section.

Serial Number and Software Version

To view your ESCORT iX's serial number and software revision, press MRK and MUTE while powering on the detector.

How To Use Preferences

To access Preferences, press and hold both the MRK and SEN buttons. ESCORT iX will display "Preferences," indicating it is in program mode.

Once the unit is in Preferences mode, the MRK button is used to review the preference categories, and the + and – buttons are used to change the individual settings within the selected option.

To exit Preferences, simply wait a few seconds without pressing a button. A "Completed" message will display, confirming your selection(s).

Example:

Here's how you would turn the Speed Display off:

- 1** Enter Preferences by pressing and holding both the MRK and SEN buttons. ESCORT iX will display "Preferences."
- 2** Press the MRK button to scroll through the categories to "Speed Display."
- 3** Since the factory setting is for Speed Display to be ON, ESCORT iX will show Speed Display as ON.
- 4** Press the + or – button to change from ON to OFF.
- 5** To complete this change, simply wait a few seconds without pressing a button. The unit will display "Completed" to confirm your selection.

NOTE: You can only access and customize the Speed Display feature while in the Advanced user mode. See the Overview of Preferences chart for details on how to switch user modes.

Settings & Preferences – Overview

Press and hold the MRK and SEN buttons to access Preferences. To exit Preferences, simply wait a few seconds without pressing a button. A **Completed** message will display confirming your selection(s).

Press MRK to go from one category to the next		Press + or – to change your setting within a category
User Mode	Advanced* Novice	Access and customize all Settings and Preferences Access and customize units and display color, (all other Settings are set to factory defaults) <i>NOTE: Switch to Advance mode to view all Preferences</i>
Pilot Mode	Scanning* Full Word	Scanning Bar with Full Word Full Word: Auto, AutoNoX, AutoLoK or Highway
Display Color	Blue* / Green / Red / Amber	Set color to match your vehicle's dash display
Speed Display	On* Off	Displays current speed Displays battery voltage
Cruise Alert	20 mph* Off / 20-160 mph	Offers double-beep alert tones if traveling below specified speed
Over Speed	70 mph* Off / 20-160 mph	Reminds you when you exceed a specified speed
Meter Mode	Standard* Spec Expert Simple	Single band with bar graph of signal strength Single band with numeric frequency Multiple bands with bar graph of signal strengths Caution (if traveling below Cruise Alert limit) Slow Down (if traveling above Cruise Alert limit)
Tones	Standard* Mild	Standard ESCORT alert tones Mild doorbell chime alert tones
AutoMute	Low / Med* / High / Off	Automatically reduces audio to preferred volume during alert

AutoLearn	On* / Off	Automatically stores and locks out false alarms
Units	English* / Metric	Units for distance and speed
Language	English* / Espanol	Language for voice and text
Voice	On* / Off	Voice announcements
GPS Filter	On* / Off	Enables GPS-powered features
AutoPower	Off 1 Hour 2 Hours 4 Hours* 8 Hours	Power turns on or off depending on your vehicle's ignition type (constant power or switched) Powers off automatically after 1 hour Powers off automatically after 2 hours Powers off automatically after 4 hours Powers off automatically after 8 hours <i>NOTE: AutoPower only works with constant power-ignition. If AutoPower is on, the display screen goes blank after 30 minutes to save screen life. Display screen will turn on automatically after you reach 10 mph</i>
Band Enables	Default* Modified	Default Settings for North America Customize the bands you want to monitor
Press SEN to modify band preferences and go from one category to the next		Press + or – to change your setting within a category
X Band	On* / Off	
K Band	On* / Off	
Ka Band	On* / Off	Freq: 33.400-36.000 Ghz <i>NOTE: When Ka Band is off, you can select separate segments of the band to turn on and off.</i>
KaN1	On* / Off	Freq: 33.660-33.900 Ghz
KaN2	On* / Off	Freq: 34.200-34.400 Ghz
KaN3	On* / Off	Freq: 34.600-34.800 Ghz
KaN4	On* / Off	Freq: 35.400-35.600 Ghz
Ka-POP	On / Off*	
Laser	On* / Off	
TSR	On* / Off	Automatically rejects traffic-flow-sensor false alarms
RDR	On* / Off	Radar Detector Rejection
Marker Enables	Default* Modified	Other, Red Light Camera, Red and Speed Camera, and Speed Trap Customize the types of locations you want to mark for future reference
Press SEN to modify marker preferences and go from one category to the next		Press + or – to change your setting within a category
Other	On* / Off	Other location
Redlight	On* / Off	Red light camera
Red & Speed	On* / Off	Red light & speed camera
Speed Camera	On* / Off	Speed camera
Speed Trap	On* / Off	Speed trap
Air Patrol	On / Off*	Known aircraft patrolled areas <i>NOTE: User cannot mark an Air Patrol location</i>
Clear Locations	Marked Lockouts Defender Format	Clear all user-marked locations. Press SEN button to confirm Clear all lockouts. Press SEN button to confirm Clear all DEFENDER Database data. Press SEN button to confirm Clear DEFENDER Database, all markers, and all lockouts. Press SEN button to confirm

*Default Setting

Restore Factory Settings

To restore ESCORT iX to its original factory settings, press and hold BRT and SEN while turning the power on. A "Restored" message will display, acknowledging the reset.

Interpreting Alerts

Although ESCORT iX has a comprehensive warning system, only experience will teach you what to expect from your detector and how to interpret what it tells you.

The specific type of radar being used, the type of transmission (continuous or instant-on) and the location of the radar source affect the alerts you receive. The following examples will give you an introduction to understanding your detector's warning system for radar and laser alerts.

Alert	Explanation
Detector begins to sound slowly; rate of alert increases until it becomes a solid tone. The signal meter ramps accordingly.	You are approaching a continuous radar source aimed in your direction.
Detector emits short alerts for a few seconds then falls silent, only to briefly alert and fall silent again.	An instant-on radar source is being used ahead of you and out of your view.
Detector suddenly sounds a continuous tone for the appropriate band received.	An instant-on radar or laser source is being used nearby. This kind of alert requires immediate attention.
Detector sends a brief laser alert.	Laser is being used in the area. Because laser is inherently difficult to detect, any laser alert may indicate a source very close by.
Detector receives weak signals. Signals may be a little stronger as you pass large, roadside objects. Signals increase in frequency.	A moving patrol car with continuous radar is overtaking you from behind. Because these signals are reflected (reflections are increased by large objects), they may or may not eventually melt into a solid point, even when the patrol car is directly behind you.
Detector alerts slowly for a while then abruptly jumps to a strong alert.	You are approaching a radar unit concealed by a hill or an obstructed curve.
Detector alerts intermittently. Rate and strength of alerts may be consistent or vary wildly.	A patrol car is traveling in front of you with a radar source aimed forward. Because signals are sometimes reflected off of large objects and sometimes not, the alerts may seem inconsistent.
Detector alerts intermittently; rate and strength of signal increases with each alert.	A patrol car is approaching from the other direction, sampling traffic with instant-on radar. Such alerts should be taken seriously.
Detector gives an X band alert intermittently.	You are driving through an area populated with radar motion sensors (e.g., door openers or burglar alarms). Since these transmitters are usually contained inside buildings or aimed toward or away from you, they are typically not as strong or lasting as a real radar encounter.

CAUTION: Overconfidence in an unfamiliar area can be dangerous. Likewise, if an alert in a commonly traveled area is suddenly stronger or on a different band than usual, speed radar may be set up nearby.

How Radar Works

Traffic radar, which consists of microwaves, travels in straight lines and is easily reflected by objects such as cars, trucks, and even guardrails and overpasses. Radar works by directing its microwave beam down the road. As your vehicle travels into range, the microwave beam bounces off your car, and the radar antenna looks for the reflections. Using the Doppler principle, the radar equipment then calculates your speed by comparing the frequency of the reflection of your car to the original frequency of the beam sent out.

Traffic radar has limitations, the most significant of these being that it typically can monitor only one target at a time. If there is more than one vehicle within range, it is up to the radar operator to decide which target is producing the strongest reflection. Since the strength of the reflection is affected by both the size of the vehicle and its proximity to the antenna, it is difficult for the radar operator to determine if the signal is from a sports car nearby or a semi truck several hundred feet away.

Radar range also depends on the power of the radar equipment itself. The strength of the radar unit's beam diminishes with distance. The farther the radar has to travel, the less energy it has for speed detection.

Because intrusion alarms and motion sensors often operate on the same frequency as X and K band radar, your detector will occasionally receive non-police radar signals. Since these X band transmitters are usually contained inside of a building or aimed toward the ground, they will generally produce much weaker readings than will a true radar encounter. As you become familiar with the sources of these pseudo alarms in your daily driving, they will serve as confirmation that the device's radar detection abilities are fully operational.



How POP Works

POP works by transmitting an extremely short burst, within the allocated band, to identify speeding vehicles in traffic. Once the target is identified, or "popped," the gun is then turned to its normal operating mode to provide a vehicle tracking history (required by law).

NOTE: According to radar gun manufacturers, tickets should not be issued in pop mode.

How Laser Works

Laser speed detection is actually light detection and ranging (LIDAR). Laser guns project a beam of invisible infrared light. The signal is a series of very short infrared light energy pulses that move in a straight line, reflecting off your car and returning to the gun. Laser uses these light pulses to measure the distance to a vehicle. Speed is then calculated by measuring how quickly these pulses are reflected, given the known speed of light.

Laser is a newer technology whose use is not as widespread as conventional radar; therefore, you may not encounter it on a daily basis. And unlike radar detection, laser is not prone to false alarms. Because laser transmits a much narrower beam than does radar, it is much more accurate in its ability to distinguish between targets and is also more difficult to detect. As a result, even the briefest laser alert should be taken seriously.

There are limitations to laser, however. Laser is much more sensitive to weather conditions than radar, and a laser gun's range will be decreased by anything affecting visibility, such as rain, fog or smoke. A laser gun cannot operate through glass, and it must be stationary to get an accurate reading. Because laser must have a clear line of sight and is subject to cosine error (an inaccuracy that increases as the angle between the gun and the vehicle increases), police typically use laser equipment parallel to the road or from an overpass. Laser can be used day or night.

How TSR Works

ESCORT iX includes a new boost in anti-falsing software to eliminate excessive alerts from erroneous X and K band sources, such as traffic flow monitoring systems. These systems, which are becoming more widely used in several countries, generate K band signals to measure the flow of traffic on a given road. Unfortunately, most detectors see this as a real threat and will alert you to it unnecessarily. Our new proprietary software, **TSR**, intelligently sorts, ranks and rejects these types of false alarms automatically. The result is ultimate protection without excessive false alarms.



How Red Light Cameras Work

Red light cameras use three basic things: a camera, a device to trigger the camera and a computer. An intersection may have more than one camera to monitor traffic from multiple directions. The trigger is typically a series of wires buried just beneath the surface of the road. These wires are separated by a pre-set distance to create a magnetic field or induction loop. Once a vehicle is in the intersection, the loop or circuit becomes closed and alerts the computer to take a picture.

In some states, tickets are issued to the car's owner, no matter who's actually driving. In this case, the red light camera only needs to photograph the vehicle's rear license plate. In other states, the actual driver is responsible for paying the ticket. In this case, the system needs a second camera in front of the car to get a shot of the driver's face.

How Speed Cameras Work

There are several types of fixed position speed cameras used, including radar, laser, induction-loop and photo-based. Radar and laser based cameras are typically mounted near the road and transmit a short range signal across the lanes monitored. Since this signal is transmitted across the road instead of down the road like with many handheld systems, detecting them in time is critical.

Another technology used is an induction loop system. This type of system utilizes wires buried just beneath the surface of the road to trigger a computer that calculates speed between the two points. Photo based systems take two sets of pictures of all passing vehicles between two separate fixed locations. Both sets of photographs are date and time stamped, which enables the system to calculate average speed between the two locations.

Fixed speed cameras can also be set up to monitor one to four lanes of traffic in the same direction. To achieve this, a sensor is installed in each lane, and a wide angle camera lens is used to photograph the vehicle that is speeding.

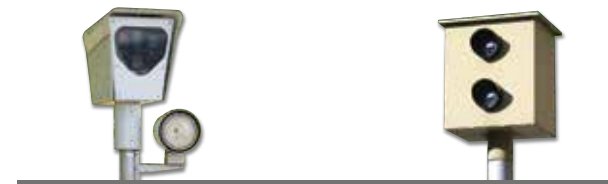

How GPS Works

Developed by the U.S. military, the global positioning system (GPS) is made up of 24 orbiting satellites. There are at least four satellites visible at any given time every day. A GPS receiver is designed to locate and receive data from four of these satellites. These data include the distance to your location from each of the satellites. Once the distance from each satellite is known, the receiver can calculate and pinpoint your exact location.



ESCORT iX's red light and speed camera Defender Database is easily updated using our exclusive detector software tools found on our website. Firmware, or the operating software for the detector, can also be updated using these tools.

To access these updates, please register your ESCORT iX at EscortRadar.com. Once registered, you will receive email notifications that updates are available for your database or firmware. To handle your software and database updates, you will need to connect ESCORT iX to a computer via USB A/mini B cable (not included).

Problem	Explanation/Solution
Detector beeps briefly at the same location every day, but no radar source is in sight.	An X band motion sensor or intrusion alarm is located within range of your route. If you have AutoLearn enabled, the factory default setting, then ESCORT iX will store this signal after about 3 passes and no longer alert to it.
Detector did not alert when a police car was in view.	VASCAR (Visual Average Speed Computer and Recorder), a stopwatch method of speed detection, may be in use. Officer may not have radar or laser unit turned on.
Detector's audible alerts become softer after the first few alerts.	Detector is in AutoMute mode. See "AutoMute" in the Settings & Preferences section for details.
The power-on sequence reoccurs while you are driving.	A loose power connection can cause ESCORT iX to be briefly disconnected and will retrigger the power-on sequence. Check all connections.
You wish to restore the factory default settings.	Press and hold the BRT and SEN buttons while powering on the detector. A "Restored" message will display, acknowledging the reset.
The device will not turn on.	Check that vehicle ignition is on. Check all connections.
The detector feels warm.	It is normal for the device to feel warm.
The display is blank.	ESCORT iX is in Dark mode. Press the BRT button to adjust the brightness.

Service Procedure

If your ESCORT iX ever needs service, call us at 1-800-543-1608. We may be able to solve your problem over the phone. If the problem requires that you send your ESCORT iX to the factory for repair, we will provide you with a Service Order Number, which must be included on the outside of your shipping box. Ship the product prepaid insured, for your protection.

Properly pack your product and include:

- Your ESCORT iX and power cord
- Your Service Order Number
- Your name and complete return address
- Your daytime telephone number
- A description of the problem you are experiencing

ESCORT Inc.
Customer Service Department
Return Authorization Number _____
5440 West Chester Road
West Chester OH 45069

ESCORT Extended Service Plan



ESCORT offers an optional extended service plan. Contact ESCORT Sales for details at 800-433-3487.

Parts & Accessories

The following accessories and replacement parts are available for ESCORT iX:

- SmartCord USB
- DirectWire SmartCord
- Laser ShifterPro System
- EZ Mag Mount™
- Travel Case

Visit EscortRadar.com for selection and pricing.

 **800.433.3487**
 **EscortRadar.com**

ESCORT One-Year Limited Warranty

What this warranty covers: Escort, Inc. ("Escort") warrants your Product against all defects in materials and workmanship.

For how long: One (1) year from the date of original purchase from an authorized Escort dealer.

What we will do: If a breach of warranty occurs, Escort, at its discretion, will either repair or replace your Product free of charge.

What we will not do: Escort will not pay shipping charges that you incur for sending your Product to us.

What you must do to maintain this warranty: Show original proof of purchase or receipt from an authorized Escort dealer.

Warranty exclusions: This warranty does not apply to your product under any of the following conditions: 1. The serial number has been removed or modified. 2. Your product has been subjected to misuse or damage (including water damage, physical abuse, and/or improper installation). 3. Your product has been modified in any way. 4. Your receipt or proof-of-purchase is from a non-authorized dealer or internet auction site, including E-bay, U-bid, or other non-authorized resellers. 5. You are not the original purchaser of the Product from an authorized dealer or did not receive it as a gift from the original purchaser of the Product from an authorized dealer.

To obtain service: 1. Contact Escort (1-800-543-1608) to obtain a Return Authorization Number. 2. Properly pack your Product and include: your name, complete return address, written description of the problem with your Product, daytime telephone number, and a copy of the original proof of purchase or receipt. 3. Label the outside of the package clearly with your Return Authorization Number. Ship the Product pre-paid (insured, for your protection) to: Escort, Inc., 5440 West Chester Rd., West Chester, OH 45069.

LIMITATION OF WARRANTY: The obligations set forth above are Escort's sole obligations and your exclusive remedy. Escort makes no other express warranty. Any implied warranty of merchantability or fitness for a particular purpose that may be applicable to the Product is limited in duration to the duration of this warranty. Some States do not allow limitations on how long an implied warranty lasts, so the above limitation may not apply to you. ESCORT SHALL NOT BE LIABLE FOR CONSEQUENTIAL, SPECIAL OR INCIDENTAL DAMAGES INCLUDING, WITHOUT LIMITATION, DAMAGES ARISING OUT OF THE USE, MISUSE OR MOUNTING OF THE PRODUCT. Some States do not allow the exclusion or limitation of incidental or consequential damages, so the above limitation or exclusion may not apply to you. Escort is not responsible for products lost in shipment between the owner and our service center.

Other legal rights: This warranty gives you specific legal rights, and you may also have other rights which vary from State to State.